



**2022 SALTWATER  
OWNER'S/OPERATOR'S MANUAL**

# INTRODUCTION

Thank you for choosing a Skeeter boat. This Owner's/ Operator's Manual contains information you will need for proper operation, maintenance, and care. A thorough understanding of these simple instructions will help you to obtain maximum enjoyment from your new boat. If you have any questions about the operation or maintenance of your boat, please consult a Skeeter Dealer.

Because Skeeter has a policy of continuing product improvement, this product may not be exactly as described in this Owner's/Operator's Manual. Specifications are subject to change without notice. This manual should be considered a permanent part of this boat and should remain with it even if the boat is subsequently sold.

This document contains many of Yamaha's valuable trademarks. It may also contain trademarks belonging to other companies. Any references to other companies or their products are for identification purposes only, and are not intended to be an endorsement.

## RECORD IMPORTANT INFORMATION

In addition to this manual, your Skeeter boat is supplied with component manufacturer information such as instructions, warranties, or other important information. Read these materials carefully.

Safeguard information about your Skeeter boat by recording the Hull Identification Number (HIN) and the model of your boat, and the model and serial numbers of your outboard motor, trailer, and accessories.

Your HIN is located on the top right side of the transom, above the water line. The U.S. Coast Guard requires that your HIN be permanently affixed and remain on the top right side of the transom.

### Hull

HIN \_\_\_\_\_

Date Purchased \_\_\_\_\_

Dealer/Phone \_\_\_\_\_

Ignition Key Number \_\_\_\_\_

Registration Number/State \_\_\_\_\_

**Outboard Motor**    Model # \_\_\_\_\_    Serial # \_\_\_\_\_

**Trailer**    Model # \_\_\_\_\_    Serial # \_\_\_\_\_

**Trolling Motor**    Model # \_\_\_\_\_    Serial # \_\_\_\_\_

**Accessory**    Model # \_\_\_\_\_    Serial # \_\_\_\_\_

**Accessory**    Model # \_\_\_\_\_    Serial # \_\_\_\_\_

**Accessory**    Model # \_\_\_\_\_    Serial # \_\_\_\_\_

The identification numbers are important! Keep a copy of these numbers stored in a safe place off the boat. In case of theft, damage, etc., report these numbers to the local authorities, your insurance agent, and your Skeeter Dealer.

# INTRODUCTION

## BOATING CHECKLIST

For improved safety and enjoyment, check each of these items:

### BOATER'S CHECKLIST

For improved safety and enjoyment, check each of these items:

|   |   |
|---|---|
| <p><b>CHECK BEFORE YOU LAUNCH YOUR BOAT:</b></p> <ul style="list-style-type: none"><li>• Read Owner's Manual</li><li>• Drain Plug ( Securely in place ? )</li><li>• Propeller Condition ( prop nut tight and secured, no cracked or bent blades. )</li><li>• Steering System ( Working smoothly and properly, self locking nuts in place. )</li><li>• Battery ( Fully charged, cable terminals clean and tight ? )</li><li>• Capacity Plate ( Are you overpowered ? )</li><li>• Weather conditions ( Safe to go out ? )</li><li>• Fuel &amp; Oil ( Sufficient for trip, check bilge area for gas odor, no leaks. )</li><li>• Hoses &amp; Connectors ( no leaks or damage. )</li><li>• Electrical equipment ( Lights, horn, pumps, etc. )</li><li>• Safety Equipment ( Fire extinguisher, bailer, paddle, anchor and line, mooring lines, signaling device, tool kit, first aid kit, first aid manual. )</li><li>• Float Plan submitted to Responsible Person ( verbal or written. )</li></ul> | <p><b>CHECK BEFORE YOU START YOUR ENGINE:</b></p> <ul style="list-style-type: none"><li>• Fuel ( Sufficient for trip, check bilge area for gas odor. )</li><li>• Control in Neutral</li><li>• Capacity Plate ( Are you overloaded ? )</li><li>• Personal Flotation Devices on all occupants.</li><li>• Seating ( Everyone in proper place ? )</li><li>• Lanyard Stop Switch ( Operational and securely fastened ? )</li><li>• No one in water near boat</li><li>• Keep a firm and continuous grip on the steering wheel</li></ul> |
|---|---|

**RECOMMENDED ON-PLANE SEATING LOCATIONS**

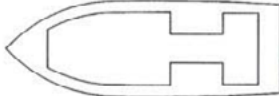

**WARNING**

DO NOT RIDE OR OPERATE BOAT WHEN UNDER POWER OF MAIN ENGINE WHILE SEATED OR LYING ON ELEVATED DECK AREAS. THIS BOAT SHOULD BE OPERATED ONLY BY A TRAINED AND EXPERIENCED OPERATOR. FAILURE TO HEED THIS WARNING MAY RESULT IN INJURY.

## BOATING TERMINOLOGY

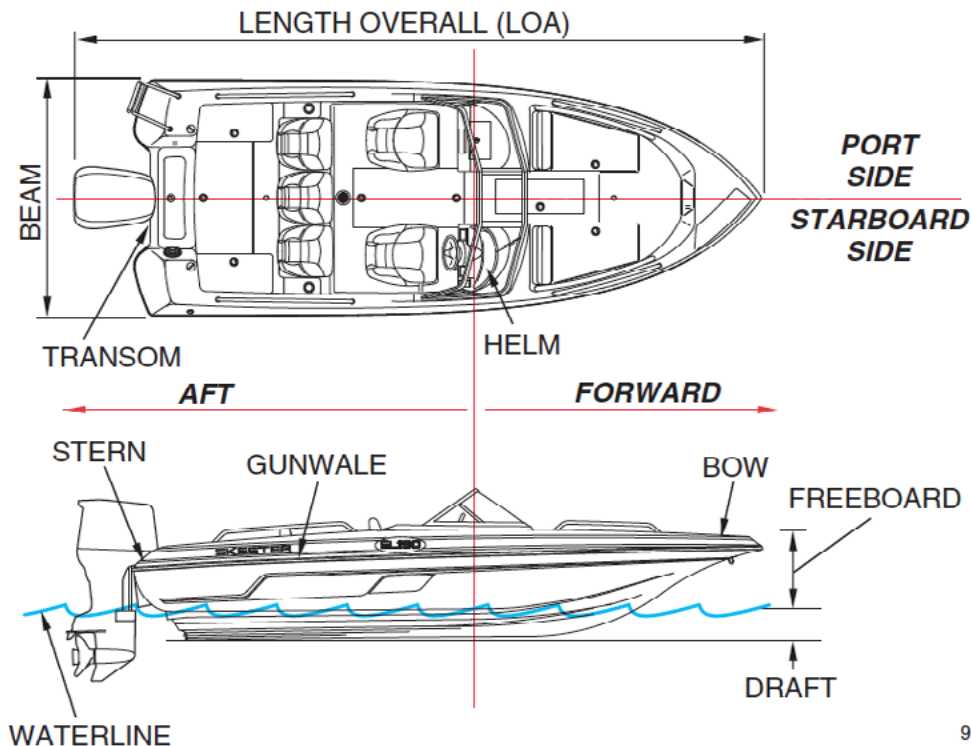

An easy way to remember PORT side from STARBOARD side is "PORT" and "LEFT" both have four letters.

# INTRODUCTION

|  |            |                                 |             |
|--|------------|---------------------------------|-------------|
| <b>1</b>                                     |            | <b>6</b>                        |             |
| <b>Boating Safety</b> .....                  | <b>1-1</b> | <b>Operation</b> .....          | <b>6-1</b>  |
| Important Manual Information .....           | 1-1        | Driving Your Skeeter Boat ..... | 6-2         |
| Safety Information .....                     | 1-1        | Boat Trim .....                 | 6-4         |
| Limitations on Who May Operate the Boat....  | 1-1        |                                 |             |
| Overpowering/Under-powering.....             | 1-2        | <b>7</b>                        |             |
| Boat Setup/Engine Height .....               | 1-3        | <b>Getting Under Way</b> .....  | <b>7-1</b>  |
| Design and Construction .....                | 1-4        | Safety Checklist.....           | 7-1         |
| Required Equipment.....                      | 1-4        | Safety Equipment .....          | 7-1         |
| Additional Equipment Recommendations.....    | 1-4        | Boarding .....                  | 7-1         |
| Operational Requirements.....                | 1-5        |                                 |             |
| Cruising Limitations .....                   | 1-5        | <b>8</b>                        |             |
| Hazard Information .....                     | 1-6        | <b>Running</b> .....            | <b>8-1</b>  |
| Night Operation .....                        | 1-6        | Maneuvering Techniques.....     | 8-1         |
| Water-Skiing .....                           | 1-6        | Anchoring .....                 | 8-2         |
| To Get More Boating Safety Information ..... | 1-7        | Performance Boating.....        | 8-2         |
| Accident Reporting .....                     | 1-8        | Propellers .....                | 8-3         |
| Pre-Operation Checks Checklist .....         | 1-8        | Post-Operation Checks .....     | 8-3         |
| Check Points .....                           | 1-8        | Trailing .....                  | 8-4         |
| Enjoy Your Skeeter Boat Responsibly .....    | 1-13       |                                 |             |
|  |            | <b>9</b>                        |             |
| <b>2</b>                                     |            | <b>Care / Maintenance</b> ..... | <b>9-1</b>  |
| <b>Basic Rules of the Road</b> .....         | <b>2-1</b> | Repairs and Modifications ..... | 9-1         |
| Rules of the Road.....                       | 2-1        | Electrical .....                | 9-1         |
| Rules When Encountering Vessels .....        | 2-2        | Corrosion Protection.....       | 9-3         |
| Regulated / Limited Access Areas.....        | 2-5        | General Maintenance .....       | 9-4         |
|  |            | Fuel System.....                | 9-5         |
| <b>3</b>                                     |            | Motor Mounts.....               | 9-6         |
| <b>Saltwater Boats</b> .....                 | <b>3-1</b> | Steering System .....           | 9-8         |
| Safety Labels.....                           | 3-1        | Service / Maintenance Log.....  | 9-9         |
| Helm Layouts.....                            | 3-3        |                                 |             |
| Switch Panel Layouts .....                   | 3-7        | <b>10</b>                       |             |
| Deck Layouts.....                            | 3-8        | <b>Troubleshooting</b> .....    | <b>10-1</b> |
| Equipment .....                              | 3-14       | Trouble Check Chart .....       | 10-1        |
|  |            |                                 |             |
| <b>4</b>                                     |            | <b>11</b>                       |             |
| <b>Controls / Indicators</b> .....           | <b>4-1</b> | <b>Storage</b> .....            | <b>11-1</b> |
| Steering .....                               | 4-1        | Preparing Boat for Storage..... | 11-1        |
| Outboard Motor Trim .....                    | 4-1        | Lifting .....                   | 11-2        |
| Instruments.....                             | 4-3        | Trailing.....                   | 11-3        |
| Switches .....                               | 4-4        |                                 |             |
| Circuit Breakers / Fuses .....               | 4-5        | <b>12</b>                       |             |
|  |            | <b>Glossary of Terms</b> .....  | <b>12-1</b> |
| <b>5</b>                                     |            |                                 |             |
| <b>Boat Systems</b> .....                    | <b>5-1</b> | <b>Float Plan</b> .....         | <b>F-1</b>  |
| Electrical System.....                       | 5-1        |                                 |             |
| Fuel System.....                             | 5-1        | <b>Warranty</b> .....           | <b>W-1</b>  |
| Bilge.....                                   | 5-2        |                                 |             |

# BOATING SAFETY

## IMPORTANT MANUAL INFORMATION

In this manual, information of particular importance is distinguished in the following ways:



The Safety Alert Symbol means  
**ATTENTION! BECOME ALERT!**  
**YOUR SAFETY IS INVOLVED!**



Failure to follow **WARNING** instructions could result in severe injury or death to the boat operator or passengers, a bystander, or a person inspecting or repairing the boat.



A **CAUTION** indicates special precautions that must be taken to avoid damage to the boat.

**NOTE:** A NOTE provides key information to make procedures easier or clearer.

## SAFETY INFORMATION

The safe use and operation of this boat is dependent upon the use of proper operating techniques, as well as upon the common sense, good judgment, and expertise of the operator. Every operator should know the following requirements before operating the boat.

- Before operating the boat, read this Skeeter Owner's/Operator's Manual, the Owner's/Operator's Manual for the outboard motor, the literature for all other equipment supplied with your boat or trailer, and all warning and caution labels on the boat, motor, and trailer. These materials should give you an understanding of the boat and its operation.
- Never allow anyone to operate this boat until they too have read the Owner's/Operator's Manual and all warning and caution labels.

## LIMITATIONS ON WHO MAY OPERATE THE BOAT

- Skeeter recommends a minimum operator age of 16 years old.
- Adults must supervise use by minors.
- Know the operator age and training requirements for your state. A boating safety course is recommended and may be required in your state. You can find local rules by contacting the United States Coast Guard (USCG), the National Association of State Boating Law Administrators, or your local Power Squadron.
- This Skeeter boat has maximum capacities for number of passengers and weight on board. Never exceed these maximum load limits. Weight distribution affects performance. Keep weight in the boat low and evenly distributed from side-to-side and front-to-back. Remove any unnecessary cargo and store it on shore.

# BOATING SAFETY

## OVERPOWERING/OVERLOADING

DO NOT overpower or overload your boat. Your boat is equipped with a required capacity plate indicating the maximum acceptable power and load as determined by the manufacturer following certain Federal guidelines. In doubt, contact your Skeeter Dealer.



Typical Capacity Plate  
Figure 1-1

Using an outboard motor that exceeds the maximum horsepower limit of a boat can:

- Cause loss of boat control.
- Place too much weight at the transom, altering the design flotation characteristics of the boat.
- Cause structural damage.

Overpowering a boat can result in serious injury, death, or boat damage.



**DO NOT overpower or overload your boat.**

**NOTE:** It is recommended that you contact your Skeeter Dealer or Skeeter customer service, before adding any aftermarket item(s) to your boat (shallow water anchors, etc.) as the additional weight could adversely affect the performance of your boat.

# BOATING SAFETY

## BOAT SETUP

Your Skeeter boat is shipped from Skeeter with almost all the necessities to operate your boat. Not all boats will be equipped as others, since you have the option on how to accessorize and equip your boat.

The installation of your outboard motor is already done by Skeeter. The installation height may have to be adjusted to optimize and maximize its performance. (The installation height is the distance from the bottom of the cavitation plate to the top of a straight edge placed on the bottom of the boat.) The installation height should never be adjusted by someone who is not qualified to establish the correct installation height. The installed height is based on an average, since Skeeter cannot predetermine your boat's loads or uses. The addition of add-ons or accessories which can inhibit performance and safety should never be added as a means of trying to increase performance. If you believe you are experiencing poor performance, contact your Skeeter Dealer.

A jack plate is sometimes used on boats to adjust engine installation height. Do not use a jack plate on your Skeeter boat unless it is specifically designed for one, and then only use the Skeeter-recommended jack plate. Other jack plate installations are considered misuse and are not covered by warranty.

For jack plate operation, see the operation manual that came with your boat.

| Model   | Engine Hole | Jack Plate Setting |
|---------|-------------|--------------------|
| SX 2550 | 4th hole    | 2.00"              |
| SX 240  | 4th hole    | 2.00"              |
| SX 2350 | 4th hole    | 2.00"              |
| SX 230  | 3rd hole    | NA                 |
| SX 2250 | 4th hole    | NA                 |
| SX 210  | 3rd hole    | NA                 |

**\*\*Jack Plate measurement inside plate over outside plate**



**Do not attempt to alter your Skeeter boat to increase performance. Modifications could make your boat unsafe to use, increasing the risk of severe injury or death.**

# BOATING SAFETY

## Engine Shut-Off Switch and Cord Lanyard

Your Skeeter boat is equipped with an engine shut-off switch and cord lanyard. Skeeter strongly recommends that the cord lanyard be secured to the operator and the lock plate attached to the engine shut-off switch prior to starting the engine and anytime the engine is operating.

This device is designed to turn off the engine whenever the operator moves far enough away from the helm to activate the switch. It is strongly recommended that the operator use the cord lanyard.



- **Attach the engine shut-off cord to a secure place on your clothing, or your arm or leg while operating. Do not attach the cord to clothing that could tear loose.**
- **Do not route the cord where it could become entangled, preventing it from functioning.**
- **Avoid accidentally pulling the cord during normal operation. Loss of engine power means the loss of most steering control. Also, without engine power, the boat could slow rapidly. This could cause people and objects in the boat to be thrown forward.**

## DESIGN AND CONSTRUCTION

The U.S. Coast Guard (USCG) has regulations which describe minimum standards of safety. All Skeeter boats have been certified by the National Marine Manufacturers Association (NMMA) to meet or exceed all USCG requirements and American Boat & Yacht Council (ABYC) standards such as:

- Flotation
- Capacity
- Fuel System
- Ventilation
- Wiring
- Sound signaling device and navigation lights

## REQUIRED EQUIPMENT

The following USCG safety equipment must be provided by the owner and carried onboard.

- **Life Jackets:** One wearable life jacket (also called a Personal Flotation Device or “PFD”) for each person on board. Life jackets must be USCG approved and in good and serviceable condition (see **OPERATIONAL REQUIREMENTS** on page 1-5 for more information).
- **Throwable Flotation Device:** At least one USCG-approved throwable flotation device (Type IV).
- **Fire Extinguisher:** At least one Marine Type USCG hand-held, portable fire extinguisher (Type B-I or B-II).
- **Visual Distress Signals:** It is recommended that a USCG-approved pyrotechnic device be stored on your boat. A mirror or distress flag can also be used as an emergency signal.

Your Skeeter Dealer will be happy to assist you with these requirements.



# BOATING SAFETY

---

## ADDITIONAL EQUIPMENT RECOMMENDATIONS

The following equipment can help make your boating experience safer and more enjoyable:

- Cell phone and charger
- Mooring fenders and lines for docking
- Anchor with suitable line (a “Danforth” type anchor and line that is at least 6 times the depth of the water where you will drop anchor are recommended)
- Manual-type bilge pump
- First aid kit
- Waterproof flashlight with extra batteries
- Tool kit with assorted screwdrivers, pliers, wrenches (including metric sizes), and electrical tape
- Oar or paddle (look for one with a boat hook on the other end)
- Spare parts, such as an extra set of spark plugs and fuses
- Navigation charts or mobile app for the waters where you will be boating
- Towrope
- Portable GPS or marine navigation app

## OPERATIONAL REQUIREMENTS

- The operator and all passengers should wear a USCG-approved life jacket. USCG regulations require that the proper number and type of life jackets be aboard the boat for each adult passenger and worn by each child under 13 years old. However, some foreseeable accidents could happen so quickly on any boat that there would not be time to put on a life jacket. Therefore, Skeeter recommends life jacket use at all times while the boat is in operation.
- Eye protection is recommended to keep wind, water, and glare from the sun out of your eyes while you operate your Skeeter boat. Restraining straps for eyewear are made which are designed to float should your eyewear fall into the water.
- Footwear and gloves are recommended.
- NEVER operate the boat after consuming alcohol or taking drugs.
- For reasons of safety and proper care of your Skeeter boat, always perform the pre-operation checks listed on page 1-8 before operating.
- Passengers must always sit in a designated seating area, place feet on the deck, and hold on to the hand grips when the boat is in motion.
- Always consult your doctor on whether it is safe for you to ride in this boat if you are pregnant or in poor health.
- Do not attempt to modify this Skeeter boat! Modifications to your boat may reduce safety and reliability, and render the boat unsafe or illegal to use.
- Attach the engine shut-off cord (lanyard) to the operator’s life jacket and keep it free from steering wheel or other controls so that the engine stops if the operator accidentally leaves the helm. Failure to attach the engine shut-off cord could result in a runaway boat if the operator is ejected.
- After operation, remove the engine shut-off cord and the keys to avoid accidental starting or unauthorized use by children or others.

# BOATING SAFETY

---

## CRUISING LIMITATIONS

- Scan constantly for people, objects, and other watercraft. Be alert for conditions that limit your visibility or block your vision of others.
- Operate defensively at safe speeds and keep a safe distance from people, objects, and other watercraft.
- Do not follow directly behind other boats.
- Do not go near others to spray or splash them with water.
- Avoid sharp turns or other maneuvers that make it hard for others to avoid you or understand where you are going.
- Avoid areas with submerged objects or shallow water.
- Operate within your limits and avoid aggressive maneuvers to reduce the risk of loss of control, ejection, and collision.
- This is a high-performance boat – not a toy. Sharp turns or jumping waves or wakes can increase the risk of back/spinal injury (paralysis), facial injuries, and broken legs, ankles, and other bones. Do not jump waves or wakes.
- Do not operate the boat in rough water, bad weather, or when visibility is poor; this may lead to an accident causing injury or death. Be alert to the possibility of bad weather. Take note of weather forecasts and the prevailing weather conditions before setting out in your boat.
- Leave a “float plan” with a responsible person on shore. Tell where you plan to go and when you plan to arrive, and provide a description of your boat. Advise this person if your plans change and also when you arrive to prevent false alarms. A sample float plan is included in this manual.

## HAZARD INFORMATION

- Never start the engine or let it run for any length of time in an enclosed area. Exhaust fumes contain carbon monoxide, a colorless, odorless gas that may cause death within a short time. Always operate the boat in an open area.
- Do not use the reverse function to slow down or stop the boat as it could cause you to lose control, be ejected, or impact the steering wheel or other parts of the boat. This could increase the risk of serious injury. It could also damage the shift mechanism.
- Reverse can be used to slow down or stop during slow-speed maneuvering, such as when docking. Once the engine is idling, shift to reverse and gradually increase engine speed. Make sure that there are no obstacles or people behind you before shifting into reverse.
- Stop the engine and remove the clip from the engine shut-off switch before removing any debris or weeds which may have collected around the propeller.

## NIGHT OPERATION

When using your boat before dawn or after dusk, you must have both bow and stern lights operating. When at anchor in the dark, the stern light must be lit. See page 4-4 for more information.

# BOATING SAFETY

---

## WATER-SKIING

Some Skeeter boats are equipped to tow a water skier, using the tow cleat or ski pylon provided. It is the boat operator's responsibility to be alert to the safety of the water-skier and others. Know and follow all state and local water-skiing regulations in effect for the waters in which you will be operating. The following are some important considerations for minimizing risks while water-skiing. The skier should wear an approved PFD, preferably a brightly colored one so boat operators can see the skier.

- The skier should wear protective clothing. Severe internal injuries can occur if water is forced into body cavities as a result of falling into the water. Skiers should wear shorts with neoprene (wet suit material).
- A second person should be on board in a rear facing seat as a spotter to watch the skier; in most states it is required by law. Let the skier direct the operator's control of speed and direction with hand signals.
- When preparing to pull a skier, operate the boat at the slowest possible speed until the boat is well away from the skier and slack in the towrope is taken up. Make sure that the rope is not looped around anything.
- After checking that the skier is ready and that there is no traffic or other obstacles, apply enough throttle to raise the skier.
- Make smooth, wide turns. The boat is capable of very sharp turns, which could exceed the abilities of the skier. Keep the skier at least 50 meters (150 feet), about twice the distance of a standard towrope, away from any potential hazard.
- Be alert to the hazard of the towrope handle snapping back at the boat when the skier falls or is unable to get up on the skis.

## TO GET MORE BOATING SAFETY INFORMATION

Be informed about boating safety. Additional publications and information can be obtained from many organizations, including the following.

United States Coast Guard  
Boating Safety Division  
2100 2nd Street, Stop 7581  
Washington, D.C. 25093-1062

### Boating Safety Websites

U.S. Coast Guard - [www.uscgboating.org](http://www.uscgboating.org)

U.S. Coast Guard Auxiliary - [www.cgaux.org](http://www.cgaux.org)

National Association of State Boating Law Administrators - [www.nasbla.org](http://www.nasbla.org)

National Safe Boating Council - [www.safeboatingcouncil.org](http://www.safeboatingcouncil.org)

National Water Safety Congress - [www.watersafetycongress.org](http://www.watersafetycongress.org)

# BOATING SAFETY

## Boat Education and Training

The Online Boating Safety Course is available at <http://www.boatus.org>. Upon successful completion of 80% or better, the user can request a certificate of completion by mail or can download one immediately. The Online Boating Safety Course, provided by the Boat/US Foundation, is approved by the National Association of State Boating Law Administrators (NASBLA) and recognized by the United States Coast Guard. This course meets the education requirement for those states that recognize non-proctored, NASBLA-approved courses.

## ACCIDENT REPORTING

Boat operators are required by law to file a Boating Accident Report with their state boating law enforcement agency if their boat is involved in any of the following accidents:

1. There is loss of life or probable loss of life.
2. There is personal injury which requires medical attention beyond first aid.
3. There is damage to boats or other property which exceeds \$500.00.
4. There is complete loss of a boat.

Contact local law enforcement personnel if a report is necessary.

## PRE-OPERATION CHECKS CHECKLIST

Before operating this boat, perform the following checks:

If any item in the Pre-Operation Check is not working properly, have it inspected and repaired before operating your boat. Otherwise an accident could occur.

**NOTE: Pre-operation checks should be made each time the boat is used. This procedure can be accomplished thoroughly in a short time. The added safety and reliability the checks assure is worth the time involved.**

## CHECK POINTS

Perform the following in addition to the pre-operation check points provided in your outboard motor owner's manual.

### Steering

Make sure the wheel is not loose. There should not be any free play, either in-and-out or in rotation. With the engine trimmed for normal operation, turn the steering wheel full-right and full-left to make sure operation is smooth and unrestricted throughout the whole range.

Keep the steering cable end clear of obstructions such as wiring, control cables, fuel lines, tow lines, and mooring lines.

Keep moving parts clean and lubricated.

Inspect the steering cable ends/hydraulic hoses for kinks, damage, or corrosion.

## CHECK POINTS (Cont.)

### Throttle and Shifting

Operate the remote control lever several times to make sure there is no hesitation in its travel. Operation should be smooth over the complete range of motion. See your outboard owner's manual for more information.

### Fire Extinguisher

Make sure the fire extinguisher is aboard, full, and in serviceable condition. Fire extinguishers are dated for periodic servicing. See the instructions supplied by the fire extinguisher manufacturer to determine proper indication of condition.



**Always carry a fire extinguisher on board.**

### Emergency Reboarding Ladder

Your Skeeter boat is equipped with a factory installed method of reboarding. An emergency reboarding ladder will present on any Skeeter boat not equipped with a standard ladder. Take time, while your boat is on the trailer, to familiarize yourself with the location and the operation of your ladder or emergency reboarding ladder. See pictures below showing operation of emergency reboarding ladder.

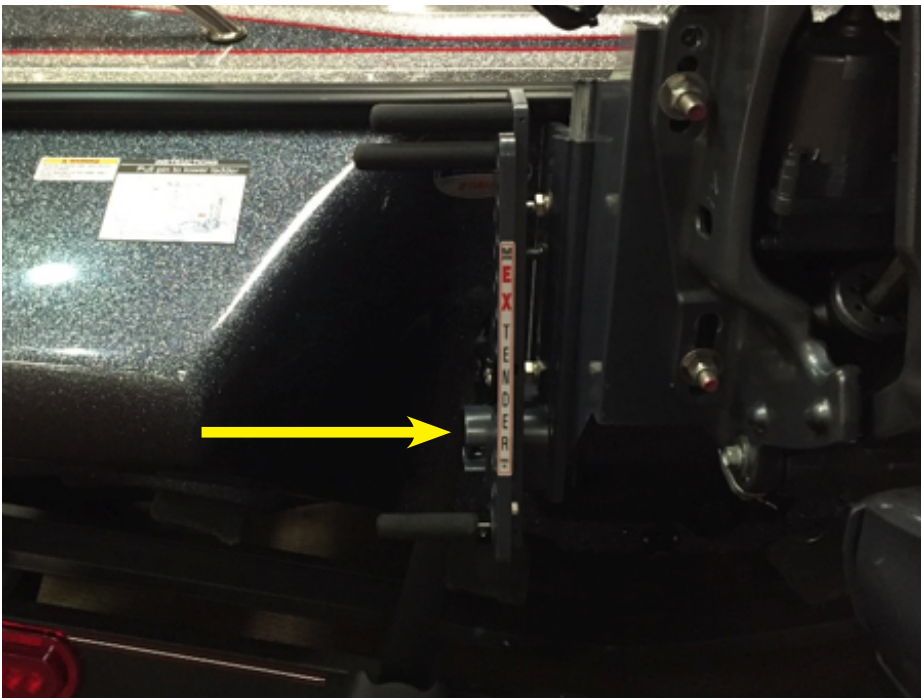

Ladder is in the stowed position, pull pin and the ladder will slide down.

**Figure 1-2**

# BOATING SAFETY

## CHECK POINTS (Cont.)

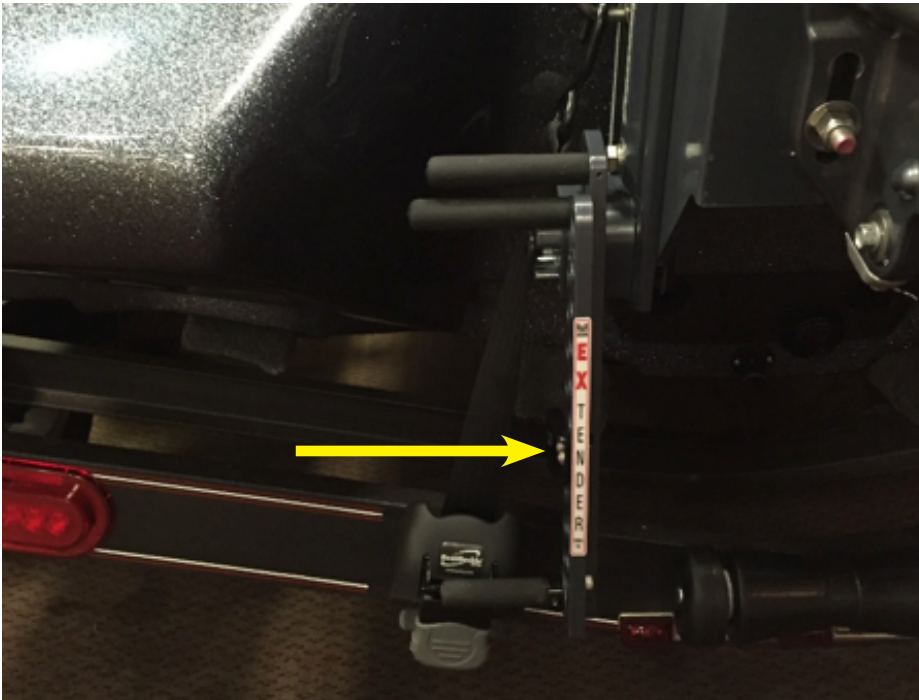

After ladder has slid down, pull second pin and the ladder will fold down.

**Figure 1-3**

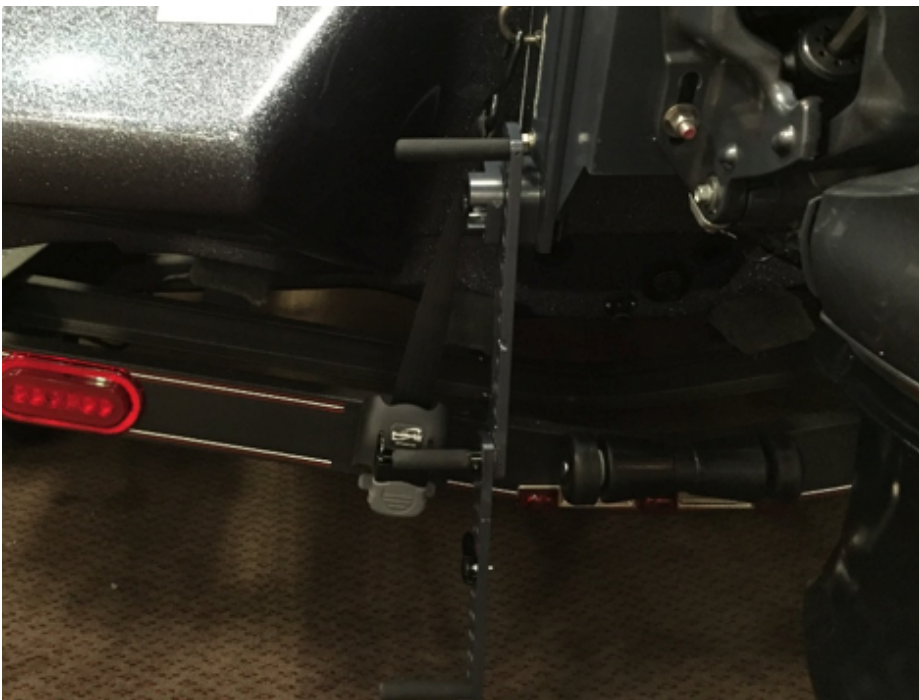

The ladder is now extended to its full depth.

**Figure 1-4**

## CHECK POINTS (Cont.)

### Hull

Before launching, check the hull of your boat for damage.

### Drainage System

**Self-Bailing Deck:** Most water which enters the deck area bails automatically out the stern through the large drain hole in the deck. A one-way check valve in the drain prevents water from traveling back to the deck during mooring or while moving in reverse.

**Bilge Pump:** Your Skeeter boat is equipped with a drainage system that channels water entering the boat from the storage compartments to the bilge under the engine compartment. When the pump is on, most of the water in the bilge will drain through the outlet. For manual bilge pump systems, the pump will operate when the bilge pump switch is turned on. If your boat is equipped with an automatic bilge pump, the pump will sense when there is excessive water in the bilge and will automatically turn on.

On boats equipped with an automatic bilge system, the bilge switch can be used to override the automatic system and to test the bilge pump. When the switch is activated, listen to hear if the pump is operating. It may not pump water unless water is present. Do not operate the bilge pump continuously when it is dry.

Inspect the bilge area frequently for evidence of excessive water. Continuous operation of the bilge pump can indicate excessive water entering the bilge. Debris can also prevent the pump from operating or make it operate continuously. Test the bilge pump at regular intervals. Make sure no debris is blocking the bilge pump float.

**Drain Plug:** A drain plug is located at the center of the stern to allow more complete draining when the boat is removed from the water.

### Lights

Check for proper operation of the bow, stern, and instrument lights by pressing the switch on the control panel. If the stern light is not installed, remove it from the storage area, lift the socket cover, and install it into the socket to check operation.

### Horn

Press the horn switch to be sure the horn operates.

### Fuel and Oil

Follow your outboard motor owner's manual for information about the proper fuel and oil for your motor.

### Engine Shut-off Switch

First, place the boat in the water to provide adequate engine cooling. Start the engine, and then remove the engine shut-off switch clip, and verify that the engine stops. See your outboard motor owner's manual for more information.

## CHECK POINTS (Cont.)

### Fuel/Oil Spillage



**Fumes from rags can collect in the bilge and be extremely hazardous. Do not store rags used to wipe up fuel or solvent spills in the boat. Dispose of rags properly ashore.**

The spilling of fuel or oil into our waterways contaminates the environment and is dangerous to wildlife. Do not discharge or dispose of fuel, oil, or other chemicals into the water; it is prohibited and you can be fined. These are two common, accidental types of discharge:

- Overfilling the fuel tanks
- Pumping contaminated bilge water

### Discharge / Disposal of Waste

Waste means all forms of garbage, plastics, recyclables, food, wood, detergents, sewage, and even fish parts in certain waters – in short, nearly everything. We recommend you bring back everything you take out with you for proper disposal ashore. Use an approved pump-out facility at your marina.

Many areas prohibit the discharge of sewage overboard or even an operable overboard waste discharge.

### Excessive Noise

Noise means engine noise, radio noise, or even voices. Many bodies of water have adopted noise limits. Music and loud conversation can carry a considerable distance on water, especially at night.

Be sure to follow regulations and be courteous.

### Wake / Wash



**You are responsible for injury and damage caused by your wake/wash.**

Be alert for NO WAKE zones. Prior to entering a no wake zone, come off plane to the slowest steerable speed. Use caution when operating around smaller crafts, in channels and marinas, and in congested areas.



# BOATING SAFETY

---

## ENJOY YOUR SKEETER BOAT RESPONSIBLY

You share the areas you enjoy when operating your boat with others and with nature. So your enjoyment includes a responsibility to treat these other people, and the lands, waters, and wildlife with respect and courtesy. Whenever and wherever you are boating, think of yourself as the guest of those around you. Remember, for example, that the sound of your boat may be music to you, but it could be just noise to others. And the exciting splash of your wake can make waves others won't enjoy. Avoid riding close to shoreline homes and waterfowl nesting areas or other wildlife areas, and keep a respectful distance from fishermen, other boats, swimmers, and populated beaches. When travel in areas like these is unavoidable, operate slowly. Remember that pollution can be harmful to the environment. Do not refuel or add oil where a spill could cause damage to nature. And keep your surroundings pleasant for the people and wildlife that share the waterways: don't litter!

When you go boating responsibly, with respect and courtesy for others, you help ensure that our waterways stay open for the enjoyment of a variety of recreational opportunities.

### **Foreign Species**

If you trailer your boat from lake to lake, you may unknowingly introduce a foreign aquatic species from one lake to the next. Thoroughly clean the boat below the water line, remove all weeds and algae, and drain the bilge before launching the boat in a new body of water.

# BASIC RULES OF THE ROAD

---

## RULES OF THE ROAD

Operation of your boat must be in accordance with the rules and regulations governing the waterway on which it is used. Just as there are rules that apply when you are driving on streets and highways, there are waterway rules that apply when you are operating your boat. These rules are used internationally, and are also enforced by the United States Coast Guard and local agencies. You should be aware of these rules, and follow them whenever you encounter another vessel on the water.

Several sets of rules prevail according to geographic location, but are all basically the same as the International Rules of the Road. The rules presented here in this Owner's/Operator's Manual are condensed, and have been provided for your convenience only. Consult your local U.S. Coast Guard Auxiliary or Department of Motor Vehicles for a complete set of rules governing the waters in which you will be operating your boat.

### Steering and Sailing Rules

Whenever two vessels on the water meet one another, one vessel has the right-of-way; it is called the "stand-on" vessel. The vessel that does not have the right-of-way is called the "give-way" or "burdened" vessel. These rules determine which vessel has the right-of-way, and what each vessel should do.

### Stand-On Vessel

The vessel with the right-of-way has the duty to continue its course and speed, except to avoid an immediate collision. When you maintain your direction and speed, the other vessel will be able to determine how best to avoid you.

### Give-Way Vessel

The vessel which does not have the right-of-way has the duty to take positive and timely action to stay out of the way of the stand-on vessel. Normally, you should not cross in front of the vessel with the right-of-way. You should slow down or change directions briefly and pass behind the other vessel. You should always move in such a way that the operator of the other vessel can see what you are doing.

The General Prudential Rule regarding the right-of way is that if a collision appears unavoidable, neither boat has the right-of-way. Both boats must avoid the collision. In other words, follow the standard rules except when a collision will occur unless both vessels try to avoid each other. If that is the case, both vessels become give-way vessels.

# BASIC RULES OF THE ROAD

## RULES WHEN ENCOUNTERING VESSELS

There are three main situations that you may encounter with other vessels which could lead to a collision unless the Steering Rules are followed:

- Meeting: you are approaching another vessel head-on
- Crossing: you are traveling across another vessel's path
- Overtaking: you are passing or being passed by another vessel

### Meeting

If you are meeting another power vessel head-on, and are close enough to run the risk of collision, neither of you has the right-of-way! Both of you should alter course to avoid an accident. You should keep the other vessel on your port (left) side. This rule does not apply if both of you will clear one another if you continue on your set course and speed.

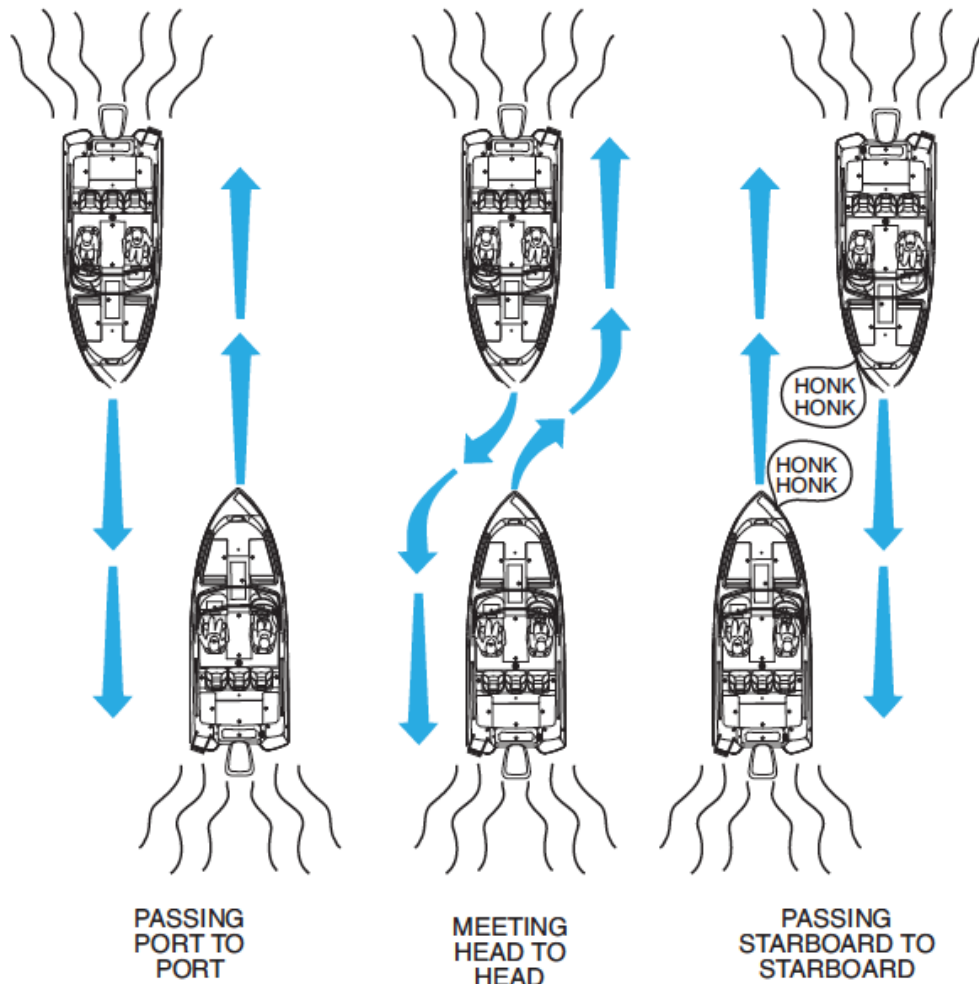

9343-005

Figure 2-1

# BASIC RULES OF THE ROAD

## RULES WHEN ENCOUNTERING VESSELS (Cont.)

### Crossing

In crossing situations, the boat to the right from the 12 o'clock to the 4 o'clock position has the right-of-way and must hold course and speed. The boat without right-of-way must yield and pass to the stern of the privileged boat. Boats going up and down a river have the right-of-way over boats crossing the river.

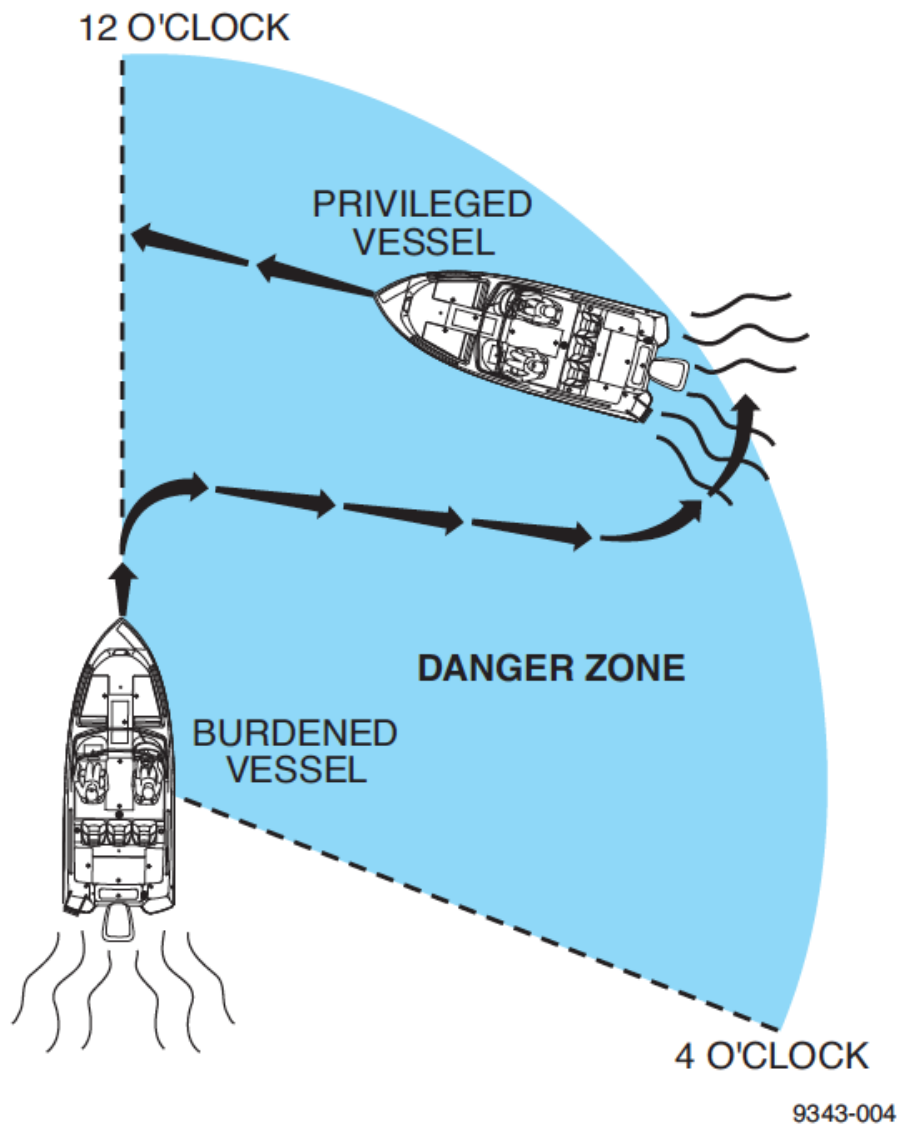

Figure 2-2

# BASIC RULES OF THE ROAD

## RULES WHEN ENCOUNTERING VESSELS (Cont.)

### Overtaking

If you are passing another vessel, you are the give way vessel. This means that the other vessel is expected to maintain its course and speed. You must stay out of its way until you are clear of it. Likewise, if another vessel is passing you, you should maintain your speed and direction so that the other vessel can steer itself around you.

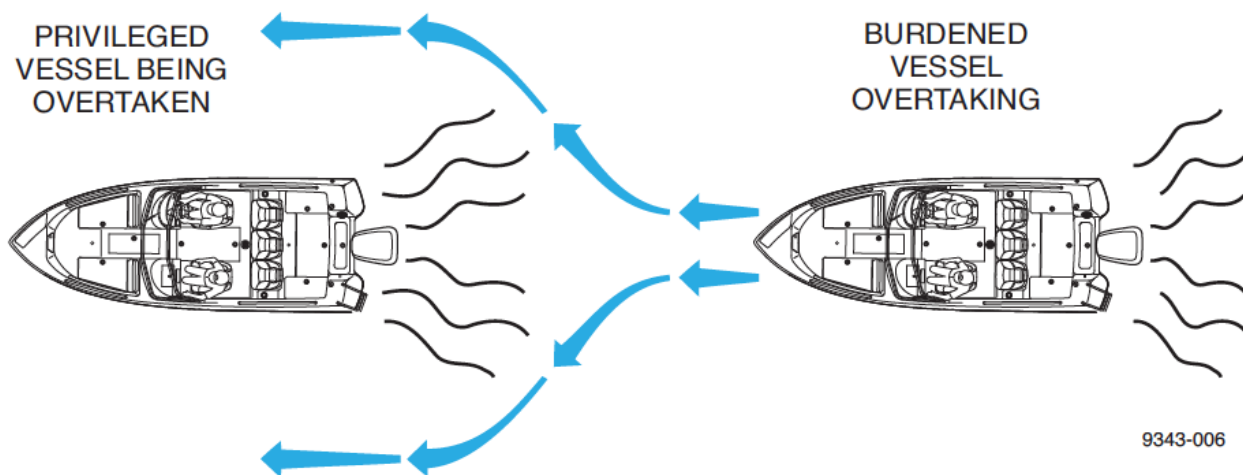

Figure 2-3

### Other Special Situations

There are three other rules you should be aware of when operating your boat around other vessels.

#### Narrow Channels and Bends

When navigating in narrow channels, you should keep to the right when it is safe and practical to do so. If the operator of a power-driven vessel is preparing to go around a bend that may obstruct the view of other water vessels, the operator should sound a prolonged blast of 4-6 seconds on the horn. If another vessel is around the bend, it too should sound the horn. Even if no reply is heard, however, the vessel should still proceed around the bend with caution.

#### Fishing Vessel Right-of-Way

All vessels fishing with nets, lines, or trawls are considered to be "fishing vessels" under the International Rules. Vessels with trolling lines are not considered fishing vessels. Fishing vessels have the right-of-way regardless of position. Fishing vessels cannot, however, impede the passage of other vessels in narrow channels.

# BASIC RULES OF THE ROAD

---

## RULES WHEN ENCOUNTERING VESSELS (Cont.)

### Sailing Vessel Right-of-Way

Sailing vessels should normally be given the right-of way. The exceptions to this are:

1. When the sailing vessel is overtaking the power driven vessel, the power-driven vessel has the right-of-way.
2. Sailing vessels should keep clear of any fishing vessel.
3. In a narrow channel, a sailing vessel should not hamper the safe passage of a power-driven vessel that can navigate only in such a channel.

### Reading Buoys and Other Markers

The waters of the United States are marked for safe navigation by the lateral system of buoyage. Simply put, buoys and markers have an arrangement of shapes, colors, numbers, and lights to show which side of the buoy a boater should pass on when navigating in a particular direction. The markings on these buoys are oriented from the perspective of being entered from seaward (the boater is going toward the harbor). Red buoys are passed on your starboard (right) side when proceeding from open water into port, and black buoys are to your port (left) side. An easy way to remember the meaning of the colors is the phrase “red right returning.” When navigating out of the harbor, your position with respect to the buoys should be reversed; red buoys should be to port and black buoys to starboard.

Many bodies of water used by boaters are entirely within the boundaries of a particular state. The Uniform State Waterway Marking System has been devised for these waters. This system uses buoys and signs with distinctive shapes and colors to show regulatory or advisory information. These markers are white with black letters and orange borders. They signify speed zones, restricted areas, danger areas, and general information.

Remember, markings may vary by geographic location. Always consult local boating authorities before riding your boat in unfamiliar waters.

## REGULATED / LIMITED ACCESS AREAS

The U.S. Coast Guard (USCG) has regulations to prevent terrorist attacks on U.S. naval vessels, cruise ships, commercial vessels, and critical infrastructure near the water such as:

- Nuclear power plants
- Petroleum facilities
- Bridges
- Dams
- Shipping channels

As a boater, not knowing how to act in certain areas or situations may put you in legal jeopardy, or worse, at risk of personal injury. You can be fined, imprisoned, or fired upon if you are perceived as a security risk. It is best to avoid these areas if possible.

# SALTWATER BOATS

This section is specific to your Skeeter saltwater boat. The picture or pictures used to show feature(s) and location may show more than your actual boat is equipped with. If you have any questions regarding your specific boat, you can always contact your Skeeter Dealer.

## SAFETY LABELS

The safety labels attached to your boat are there to protect you, your occupants, others around you, and your Skeeter boat. Read, know, and understand them. Contact your Skeeter dealer to order any decals that have been damaged, see below for part numbers.

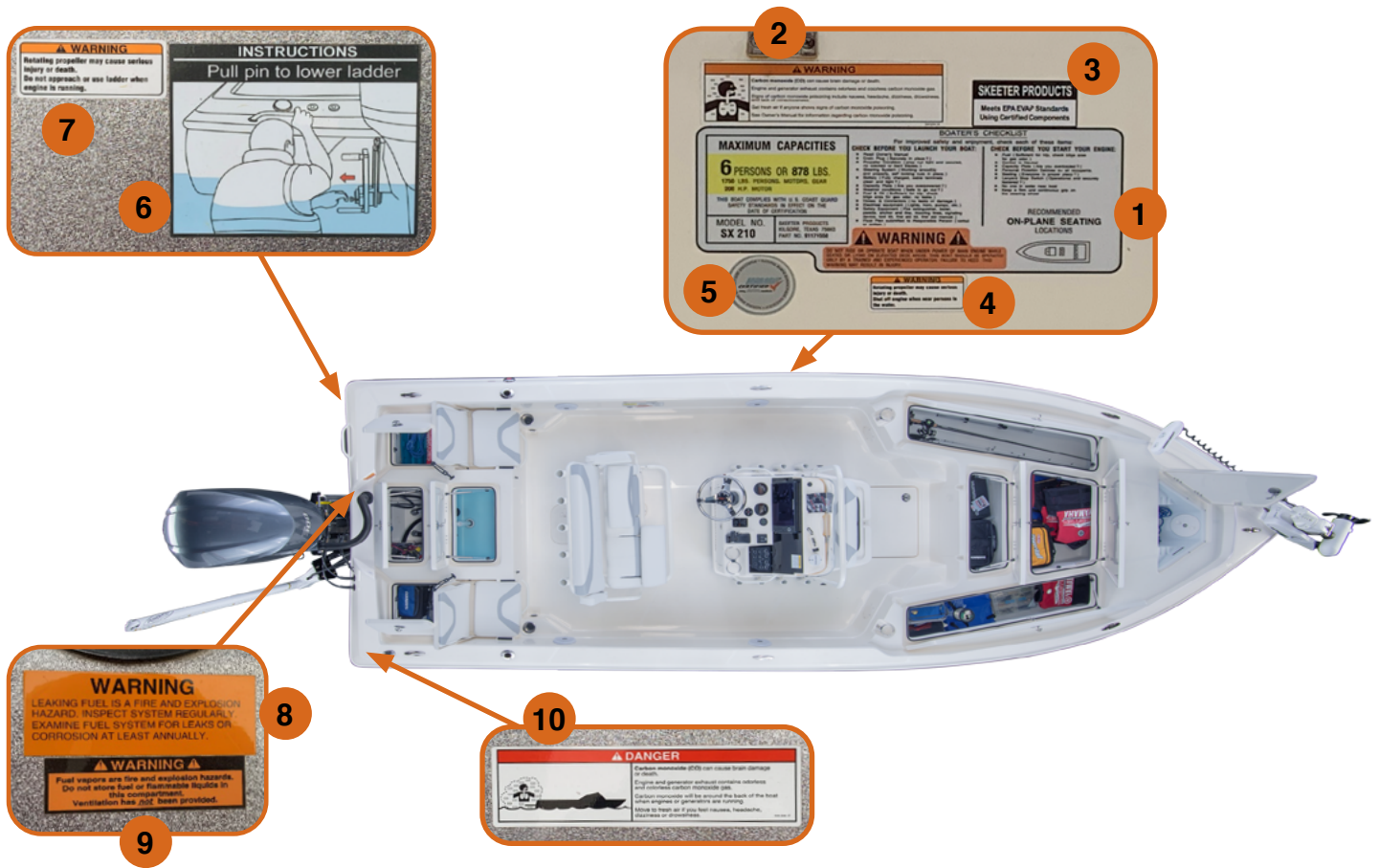

| Description | Part #                         |          |
|-------------|--------------------------------|----------|
| 1           | Plaque w/ boat decals SX 2550  | 91171619 |
|             | Plaque w/ boat decals SX 240   | 91171514 |
|             | Plaque with boat decals SX2350 | 91171692 |
|             | Plaque w/ boat decals SX 230   | 91171561 |
|             | Plaque w/ boat decals SX 2250  | 91171511 |
|             | Plaque w/ boat decals SX 210   | 91171550 |
| 2           | Decal carbon monoxide (Helm)   | 91171273 |
| 3           | Label- EPA EVAP                | 91171324 |

| Description | Part #                          |          |
|-------------|---------------------------------|----------|
| 4           | Decal ladder warning cockpit    | 91170303 |
| 5           | Decal NMMA ABYC                 | 91171226 |
| 6           | Decal ladder operation          | 91171302 |
| 7           | Decal ladder warning transom    | 91170304 |
| 8           | Decal leaking fuel              | 91171162 |
| 9           | Decal warning fuel storage      | 91170351 |
| 10          | Decal carbon monoxide (Transom) | 91171269 |

# SALTWATER BOATS

## SAFETY LABELS (Cont.)

**U. S. COAST GUARD  
MAXIMUM CAPACITIES**

**X PERSONS OR XXX LBS.**

XXXX LBS. PERSONS, MOTORS, GEAR  
XXX H.P. MOTOR

THIS BOAT COMPLIES WITH U. S. COAST GUARD  
SAFETY STANDARDS IN EFFECT ON THE  
DATE OF CERTIFICATION

**MODEL NO.**  
XX XXX

**SKEETER PRODUCTS**  
KILGORE, TEXAS 75663  
PART NO. 91171152

**BOATER'S CHECKLIST**

For improved safety and enjoyment, check each of these items:

**CHECK BEFORE YOU LAUNCH YOUR BOAT:**

- Fuel: Owners Manual
- Drain Plug (Security in place?)
- Propeller Condition (trim up tight and around, no cracked or bent blades)
- Steering System (check for smooth operation and proper, self locking when in place)
- Battery (Fully charged, visible terminals clean and tight?)
- Capacity Plate (Are you overloaded?)
- Weather conditions (Safe to go out?)
- Fuel & Oil (Sufficient for trip, check fuel lines for gas leaks, no leaks)
- Tires & Connections (No flats or damage)
- Electrical equipment (Lights, horn, stereo, etc.)
- Safety Equipment (Fire extinguisher, bilge pump, anchor and line meeting ABYC standards, first aid kit, first aid manual)
- Flood Plan submitted to Responsible Person (owner or captain)

**CHECK BEFORE YOU START YOUR ENGINE:**

- Fuel (Checkover for help, check engine time for gas color)
- Control as Required
- Capacity Plate (Are you overloaded?)
- Personal Flotation Devices on all occupants
- Seating (Everyone in proper place?)
- Lateral Trim System (Operational and securely latched?)
- No one in motor near boat
- Keep a firm and continuous grip on the steering wheel

**RECOMMENDED  
ON-PLANE SEATING  
LOCATIONS**



**WARNING**

DO NOT RIDE OR OPERATE BOAT WHICH EXCEEDS POWER OF BOAT. ALWAYS WEAR SEATED OR LYING ON ELEVATED DECK AREAS. THIS BOAT SHOULD BE OPERATED ONLY BY A TRAINED AND EXPERIENCED OPERATOR. FAILURE TO HEED THIS WARNING MAY RESULT IN INJURY.

1

**WARNING**



**Carbon monoxide (CO) can cause brain damage or death.**

Engine and generator exhaust contains odorless and colorless carbon monoxide gas. Signs of carbon monoxide poisoning include nausea, headache, dizziness, drowsiness, and lack of consciousness.

Get fresh air if anyone shows signs of carbon monoxide poisoning.

See Owner's Manual for information regarding carbon monoxide poisoning.

2

**SKEETER PRODUCTS**

Meets EPA EVAP Standards  
Using Certified Components

3

**WARNING**

**Rotating propeller may cause serious injury or death.**

**Shut off engine when near persons in the water.**

4



5

**INSTRUCTIONS**

Pull pin to lower ladder



6

**WARNING**

**Rotating propeller may cause serious injury or death.**

**Do not approach or use ladder when engine is running.**

7

**WARNING**

**LEAKING FUEL IS A FIRE AND EXPLOSION HAZARD. INSPECT SYSTEM REGULARLY. EXAMINE FUEL SYSTEM FOR LEAKS OR CORROSION AT LEAST ANNUALLY.**

8

**WARNING**

**Fuel vapors are fire and explosion hazards. Do not store fuel or flammable liquids in this compartment. Ventilation has not been provided.**

9

**DANGER**



**Carbon monoxide (CO) can cause brain damage or death.**

Engine and generator exhaust contains odorless and colorless carbon monoxide gas.

Carbon monoxide will be around the back of the boat when engines or generators are running.

Move to fresh air, if you feel nausea, headache, dizziness, or drowsiness.

10



## SX 2550 HELM LAYOUT

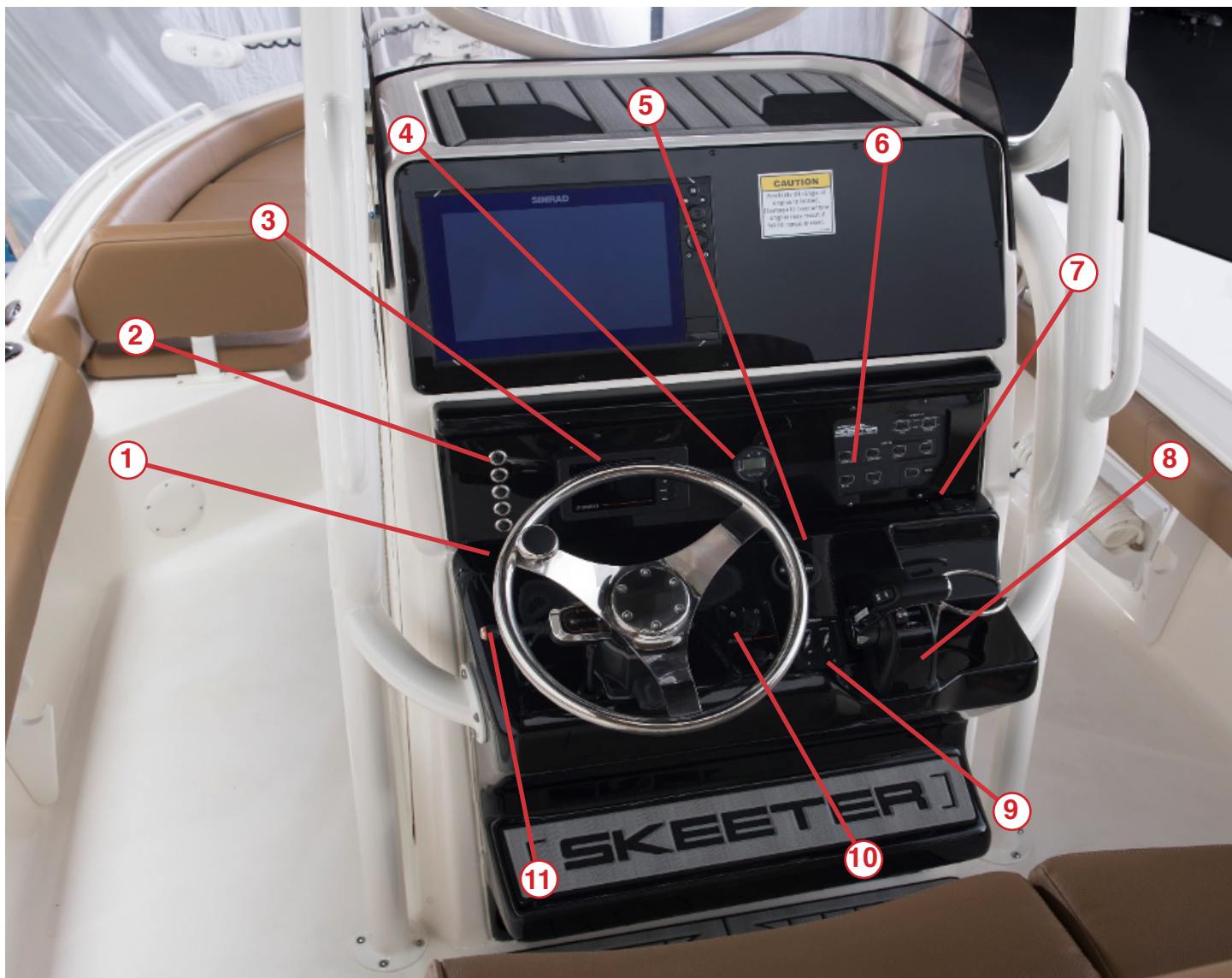

**Figure 3-1**

1. Steering fluid fill cap
2. Accessory switches
3. Multifunction gauge
4. Jackplate gauge (optional)
5. Radio
6. Switch panel
7. 12-volt outlet
8. Remote control lever
9. Trim tab controls
10. Ignition switch w/ engine shut-off switch and cord (lanyard)
11. Jackplate blinker switch (optional)

# SALTWATER BOATS

## SX240/SX2250/SX230 HELM LAYOUT



**Figure 3-2**

1. Speedometer/fuel gauge
2. Tachometer/trim gauge
3. Steering fluid fill cap
4. Cup holder
5. Jack plate gauge (optional)
6. Trim tab controls (optional)
7. Switch panel (see close up for layout)
8. Remote control lever
9. Ignition switch
10. Engine shut-off switch and cord (lanyard)
11. Bluetooth stereo (optional)
12. Jack plate blinker switch (optional)

# SALTWATER BOATS

## SX 2350 HELM LAYOUT



**Figure 3-3**

1. Steering fluid fill cap
2. Accessory switches
3. Multifunction gauge
4. Jackplate gauge (optional)
5. Radio
6. Switch panel
7. 12-volt outlet
8. Remote control lever
9. Trim tab controls
10. Ignition switch with engine shut-off switch and cord (lanyard)
11. Jackplate blinker switch (optional)

## SX210 HELM LAYOUT

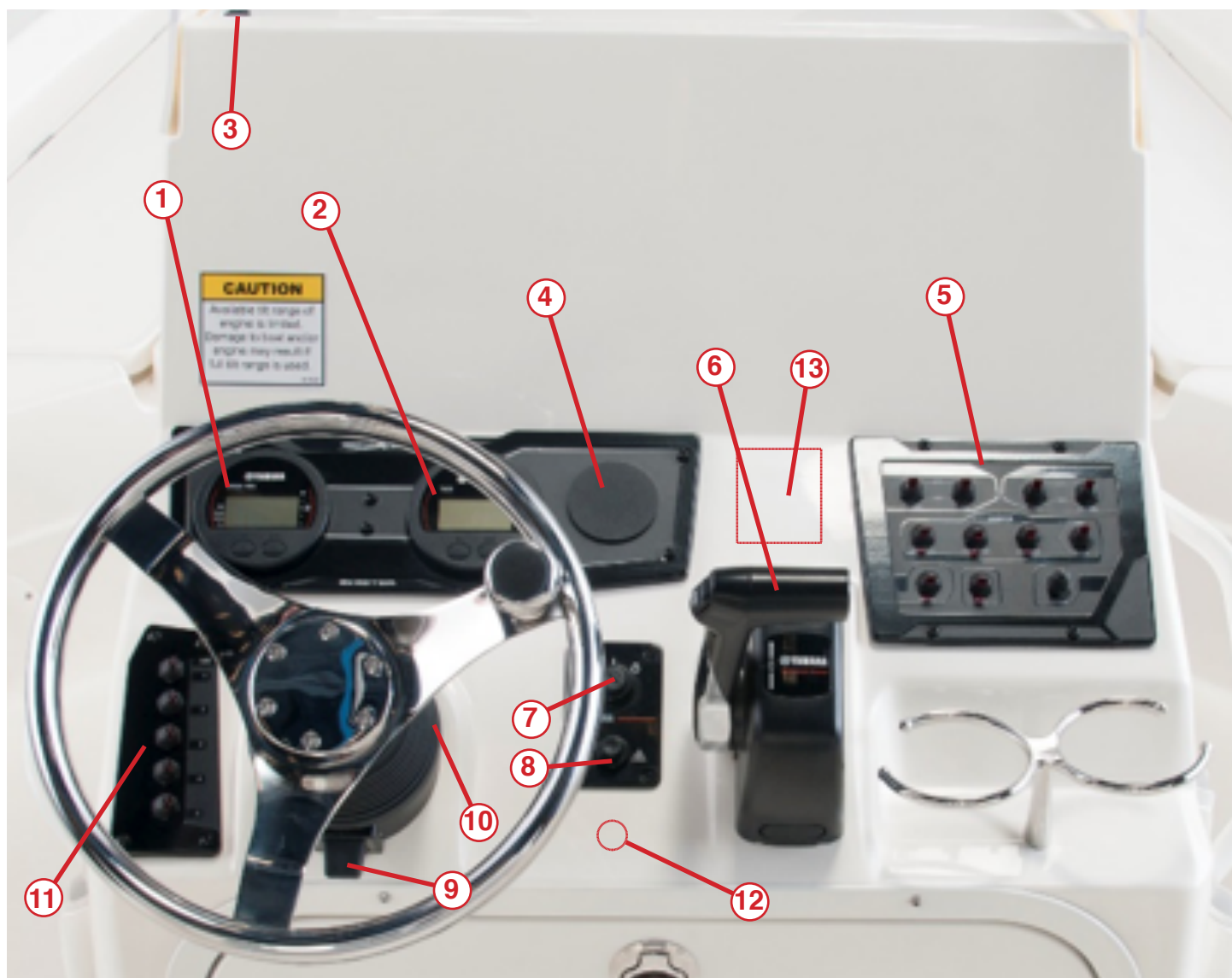

**Figure 3-4**

1. Speedometer/fuel gauge
2. Tachometer/trim gauge
3. Steering fluid fill cap
4. Jack plate gauge (optional)/blank
5. Switch panel (see closeup for switch layout)
6. Remote control lever
7. Ignition switch
8. Engine shut-off switch and cord (lanyard)
9. Tilt steering latch
10. Jack plate blinker switch (optional)
11. Accessory switch panel (optional)
12. Bluetooth® stereo (optional)
13. Trim tabs control (optional)

## SX210 SWITCH PANEL LAYOUT



Figure 3-5

## SX2250/SX240/SX230 SWITCH PANEL LAYOUT



Figure 3-6

# SALTWATER BOATS

## SX 2550 GENERAL DECK LAYOUT

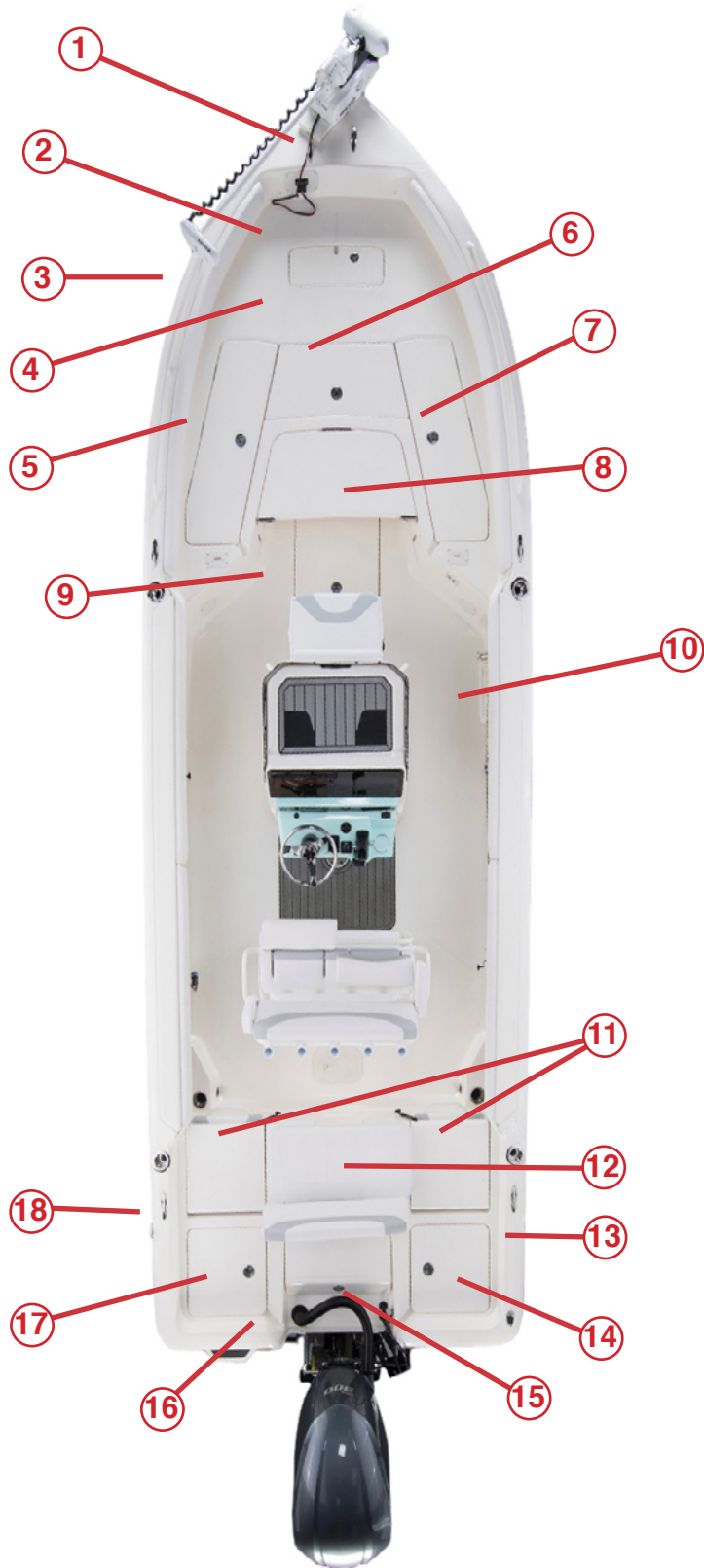

1. Pull-up cleat
2. Trolling motor plug
3. LED split bow light
4. Anchor storage box
5. Port rod box
6. Front storage box
7. Starboard rod box
8. Step / Deck extension/ table
9. Fish Box w/ Macerator pump
10. Raw water washdown
11. Jump seat / battery storage
12. Livewell (43 gallon)
13. Freshwater wash down/ Fill
14. Starboard Rear storage box
15. Rigging compartment
16. E-Ladder
17. Port Rear storage box
18. Fuel Fill

Figure 3-7

# SALTWATER BOATS

## SX240 GENERAL DECK LAYOUT

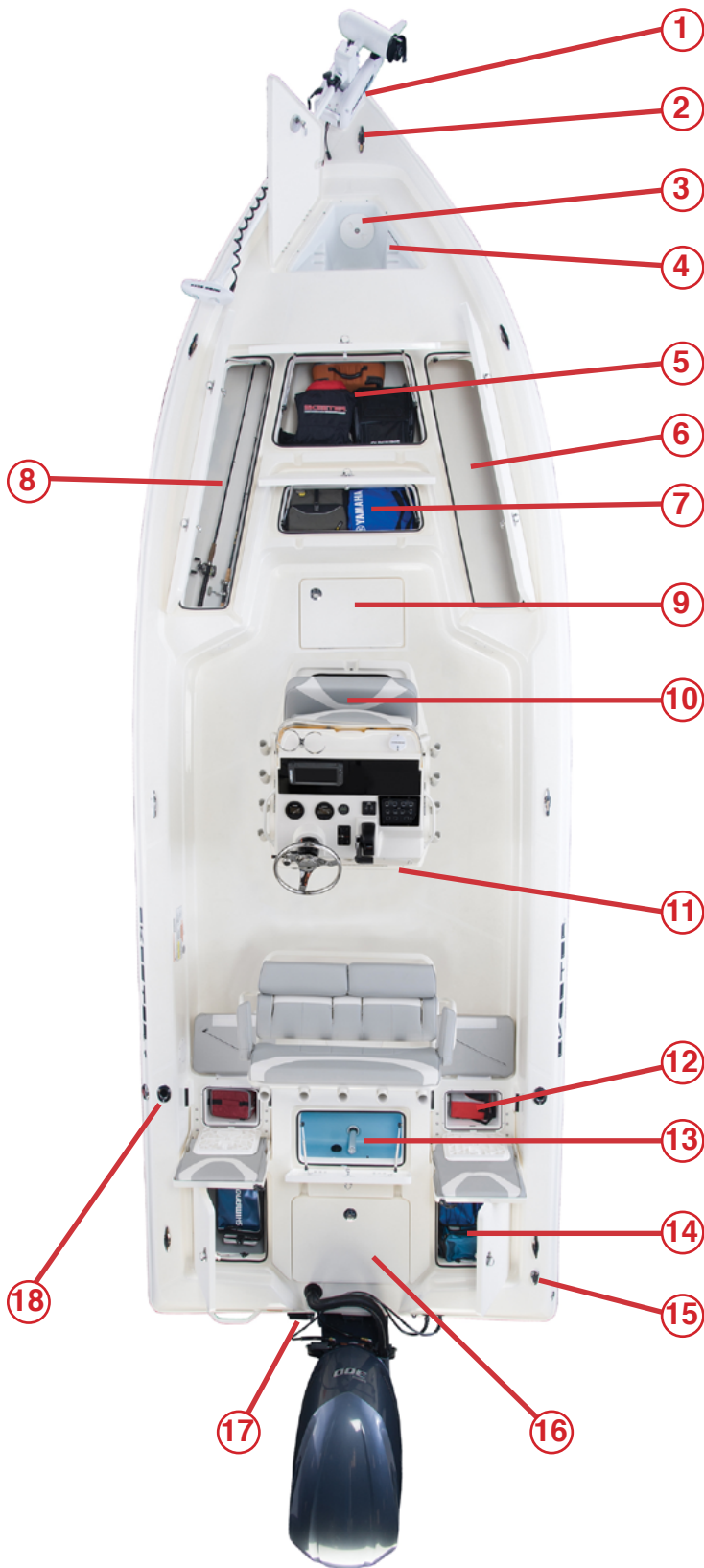

1. LED recessed bow light
2. Pull-up cleat
3. Trolling motor terminal
4. Anchor storage box
5. Front storage box
6. Starboard rod box/fish box
7. Step-up cooler
8. Port rod box
9. Cast net storage
10. Baitwell (14 gallon)
11. Storage and battery access
12. Jump seat drop-in storage
13. Livewell (40 gallon)
14. Aft storage boxes
15. Anchor light receptacle
16. Rigging compartment
17. E-ladder
18. Rod holders

Figure 3-8

# SALTWATER BOATS

## SX230 GENERAL DECK LAYOUT

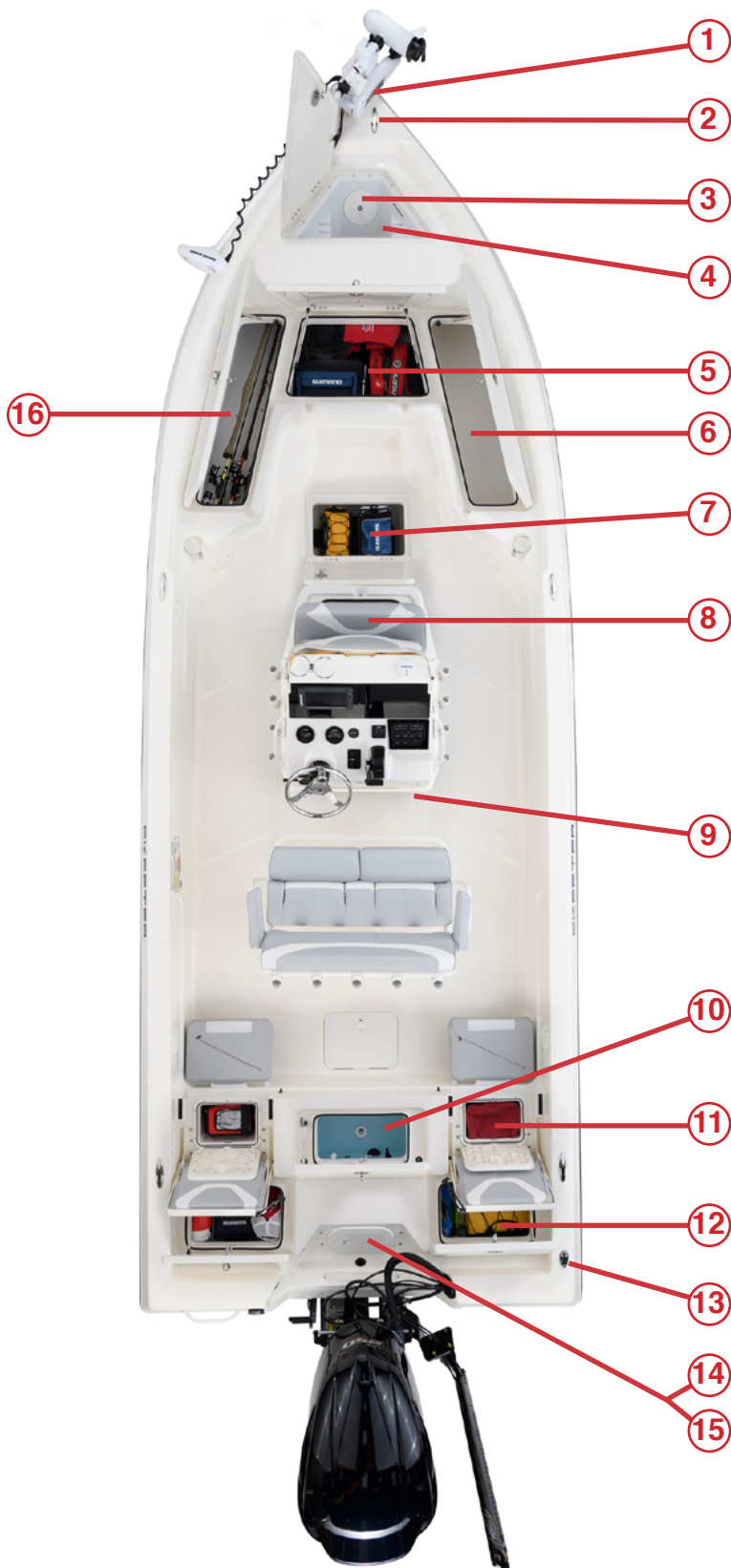

1. LED recessed bow light
2. Pull-up cleat
3. Trolling motor terminal
4. Anchor storage box
5. Center storage box
6. Starboard rod box/fish box
7. Cast net storage
8. Baitwell (14 gallon)
9. Storage and battery access
10. Livewell (22 gallon)
11. Jump seat and drop-in storage
12. Rear storage box
13. Anchor light receptacle
14. Bilge pump access
15. Livewell pump access
16. Port rod box

Figure 3-9



# SALTWATER BOATS

## SX2350 GENERAL DECK LAYOUT

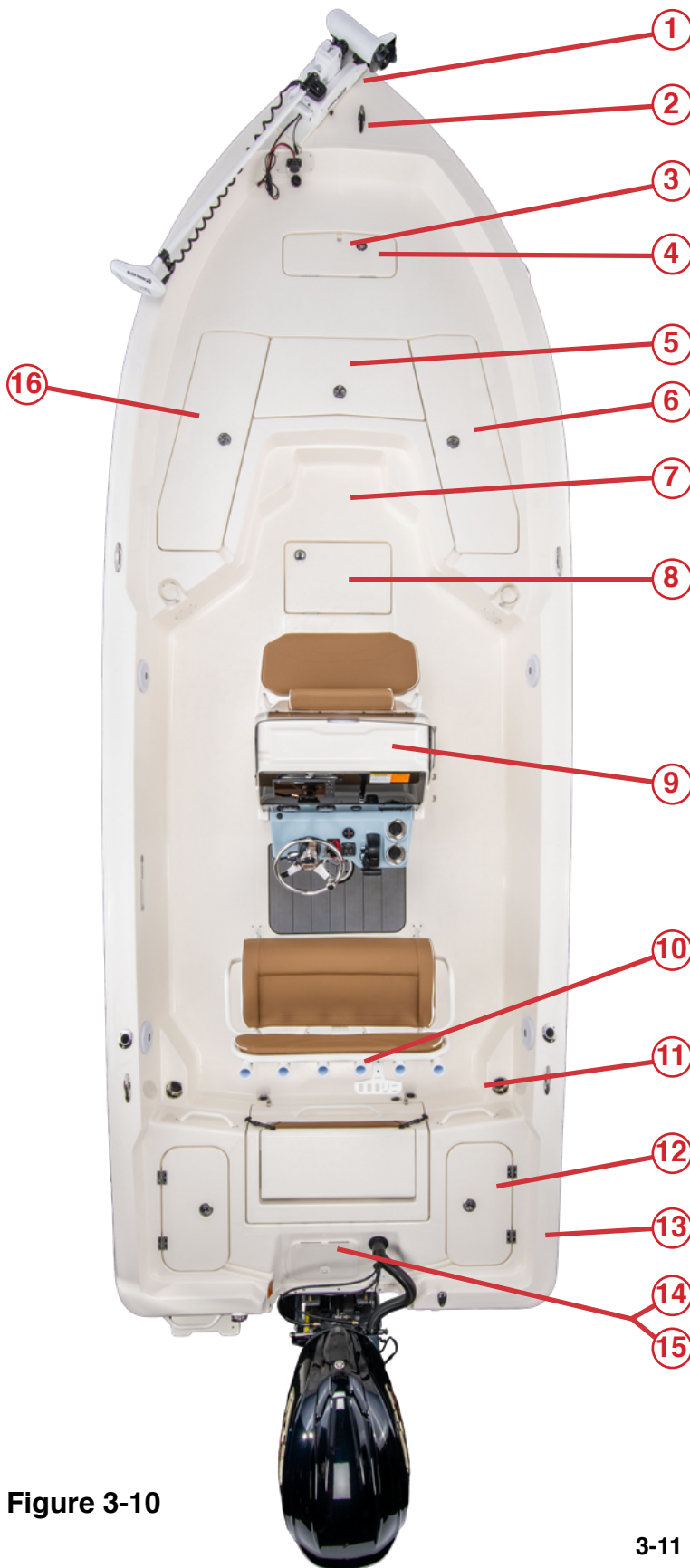

1. LED recessed bow light
2. Pull-up cleat
3. Trolling motor terminal
4. Anchor storage box
5. Center storage box
6. Starboard rod box/fish box
7. Cast net storage
8. Baitwell (14 gallon)
9. Storage and battery access
10. Livewell (22 gallon)
11. Jump seat and drop-in storage
12. Rear storage box
13. Anchor light receptacle
14. Bilge pump access
15. Livewell pump access
16. Port rod box

Figure 3-10

# SALTWATER BOATS

## SX2250 GENERAL DECK LAYOUT

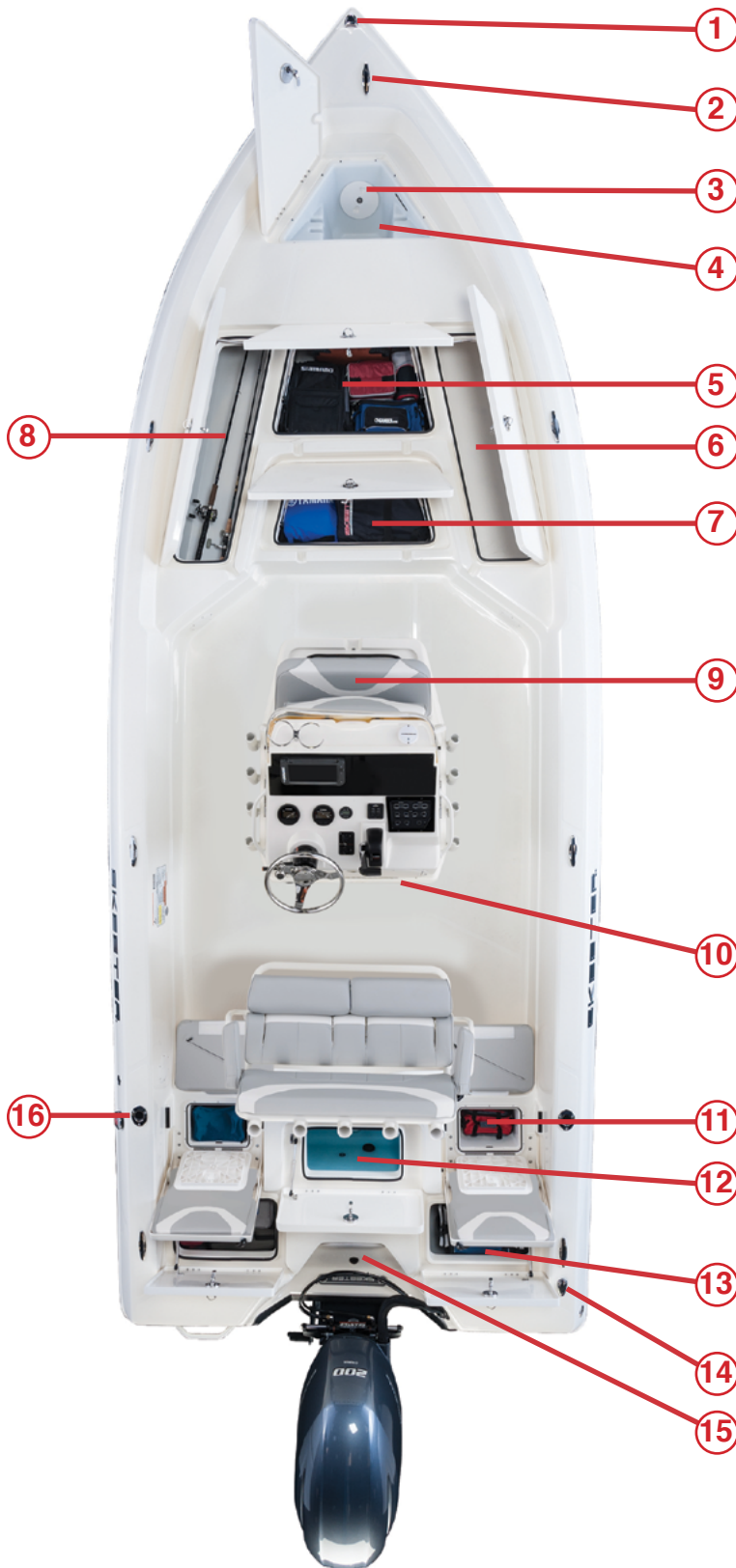

1. LED recessed bow light
2. Pull-up cleat
3. Trolling motor terminal
4. Anchor storage box
5. Front storage box
6. Starboard rod box/fish box
7. Step-up storage
8. Port rod box
9. Baitwell (14 gallon)
10. Storage and battery access
11. Jump seats
12. Livewell (30 gallon)
13. Rear storage
14. Anchor light receptacle
15. Bilge pump access
16. Rod holders

Figure 3-11

# SALTWATER BOATS

## SX210 GENERAL DECK LAYOUT

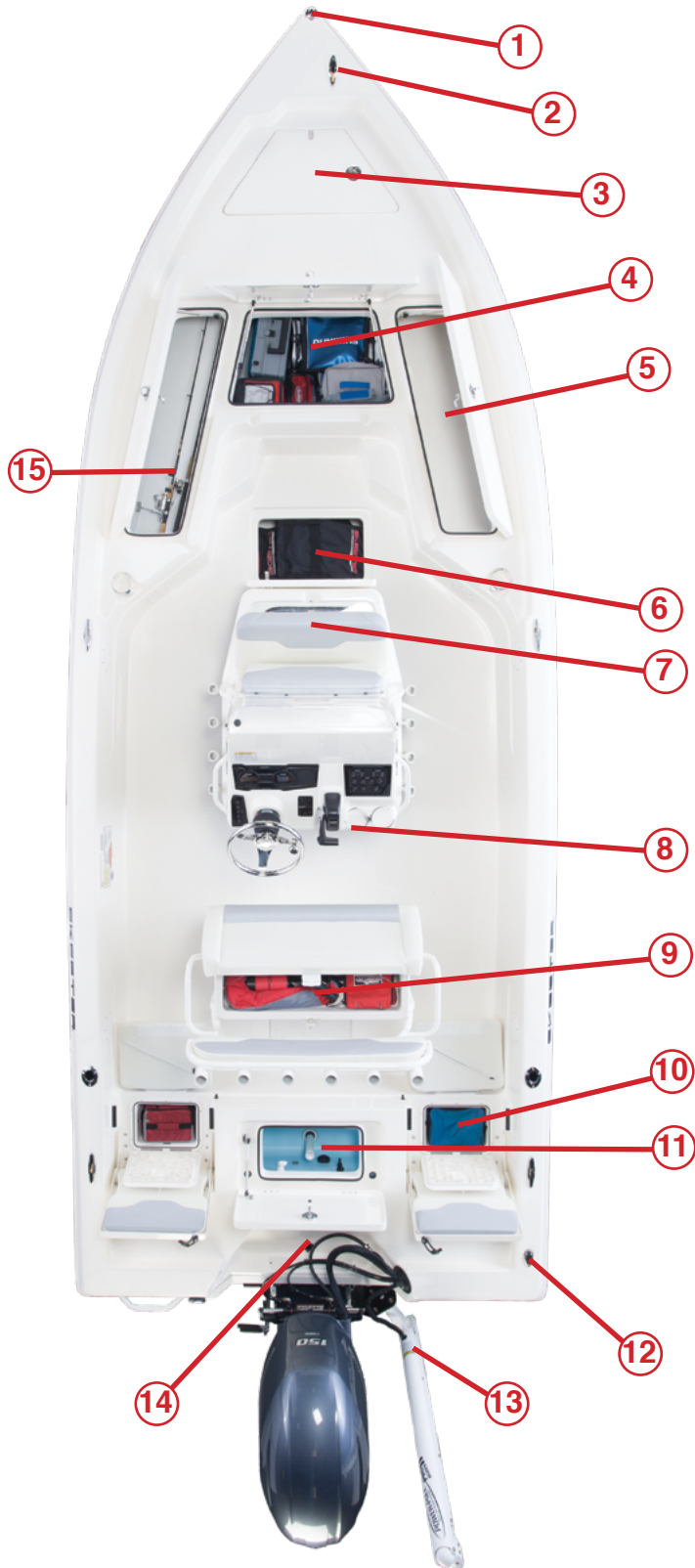

1. LED recessed bow light
2. Pull-up cleat
3. Trolling motor terminal/anchor storage box
4. Center storage box
5. Starboard rod box/fish box
6. Cast net storage
7. Baitwell (14 gallon)
8. Storage and battery access
9. Leaning post storage
10. Jump seat and drop-in storage
11. Livewell (22 gallon)
12. Anchor light receptacle
13. Shallow water anchoring device
14. Bilge pump access
15. Port rod box

Figure 3-12

## EQUIPMENT

### SX210, SX220, SX2250, SX2350, SX230, SX240 Circuit Protection

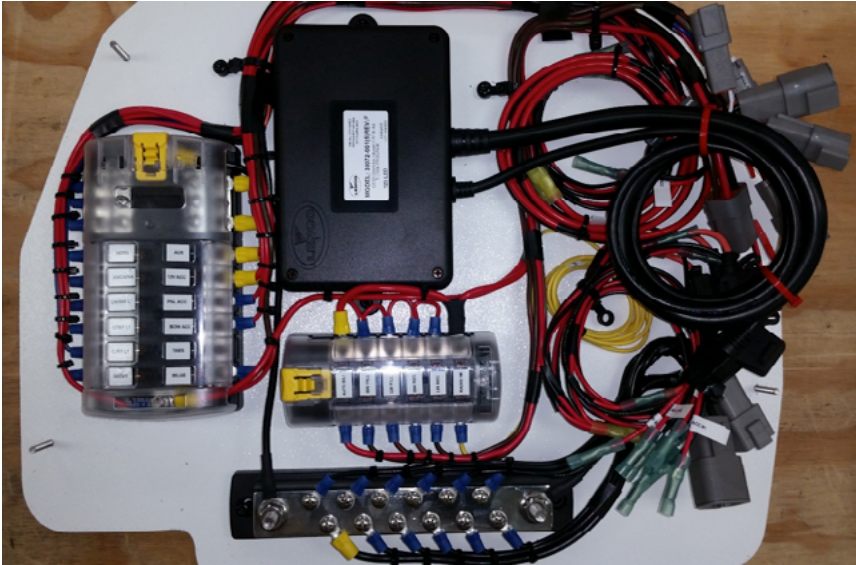

The main circuit breakers are mounted to the consoles rear wall underneath the storage shelf. Switches are independently fused as labeled in the fuse box, located inside the console on the starboard wall.

The fuse will trip when the circuit is overloaded. Before replacing the fuse determine the cause of the overload. Insert the fuse into appropriate fuse slot.

**SX210, SX220, SX2250, SX2350, SX230, SX240  
Console Circuit Breakers  
Figure 3-13**



**Never use a replacement fuse of a different color, size, or amperage rating. An improper fuse can cause damage to the electrical system which could lead to a fire.**

## Battery Switch



**Figure 3-14**

The battery switch is located inside the console door.

The switch has four positions:

- OFF: Power to all boat functions is off except to the auto bilge pump.
- 1: Power to the starter battery only.
- 2: Power to boat functions from the first 12-volt battery from the series of trolling motor batteries.
- 1+2: Power to both starter battery and the first trolling motor in the series. The starter battery and the first trolling motor battery in the series are wired parallel to each other to provide 12 volts from both batteries.

# SALTWATER BOATS

## Livewell Systems

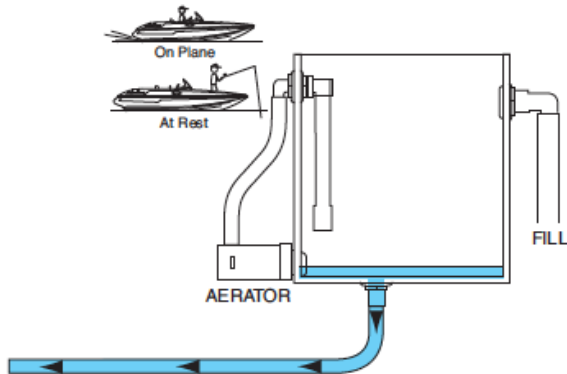

**Rear Livewell System  
Figure 3-15**

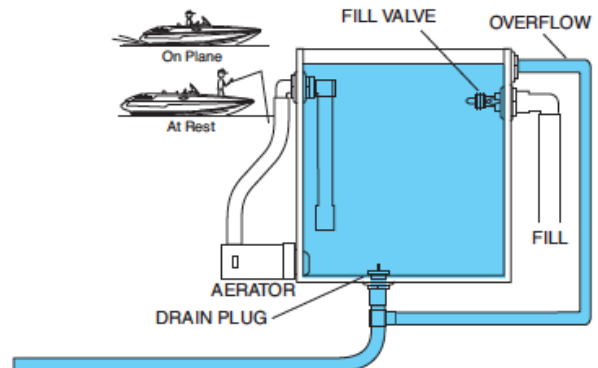

SKE-0024-A

**Console Livewell System  
Figure 3-16**

There are two livewells on saltwater boats: A rear livewell and a console bait livewell. On the rear livewell, the drain is separate from the other hoses. On the console livewell, the drain and overflow tee together. Both the livewells have fill, aerator, and recirculation switches on the console.

Rinse the livewell and baitwell (if equipped) with fresh clean water, remove any debris from the pick-up and drain screens, and allow the livewell to air-dry after each use. The pick-up screens are located at the bottom of the transom, and the drain screens are located in the livewell or baitwell.

**NOTE:** Your livewell should always be rinsed with fresh clean water. The pick-up screens and drain screens should be checked and clean before each use to optimize the system's performance and longevity.

## Seacocks



SKE-0117-A

**Figure 3-17**

There are seacocks located below the bilge pump access panel. They are valves at any water intake or discharge point that is below the water line. If a hose or through hull fitting fails, you need to close the seacock valves to avoid taking on excess outside water. Always check to make sure the valves open and close smoothly before operating the boat.

## Windshield

Most saltwater models are equipped with a windshield which can be removed to gain additional clearance when trailering or storing. After the windshield is removed, fold down the stainless rail.

## Wash-Down System (Option)



SKE-0118-A

**Figure 3-18**

The wash-down system allows you to wash your boat before and after use. The system is activated by turning on its pump switch.

### **Optional Equipment**

Your Skeeter boat may be equipped with many options which cannot all be covered in this manual. Make sure you read and understand the optional equipment's safety, use, and maintenance literature provided by the manufacturer to maximize the benefits and uses these options have to offer. Contact your Skeeter Dealer for more information or explanation.

# CONTROLS/INDICATORS

---

## STEERING

Under certain power trim positions of the outboard motor, there can be a noticeable pull on the steering wheel. This is often referred to as “steering torque.” The position of the outboard motor’s trim tab affects the amount of steering torque. See your outboard motor owner’s manual for adjustment of the trim tab. Under any circumstances, the operator should always keep a firm, continuous grip on the steering wheel.

The owner/operator must inspect the steering system frequently.

- For Hydraulic Steering, the fluid level should be checked periodically to determine the correct level.

Your Skeeter Dealer should investigate any steering system irregularities immediately. DO NOT continue to operate the boat if the steering system is malfunctioning.

## OUTBOARD MOTOR TRIM

Outboard motor trim is the angular relationship between the lower drive unit of the outboard motor and the transom of the boat. Boat trim while under way greatly affects your boat’s performance and efficiency. For best results, the boat should be on plane and trimmed to reduce the wetted surface. With less boat in the water, both speed and fuel economy increase. Outboard motors with manual trim must be adjusted for best overall operation for the load and conditions. Outboard motors with power trim should be adjusted continuously for best results.

If the outboard motor is trimmed in too far (closer to the boat bottom), speed drops, fuel economy decreases, and the boat may not handle correctly. However, it does provide better acceleration from a standstill; and because it forces the bow down, visibility is improved. If the outboard motor is trimmed out too far (away from the boat bottom), steering torque increases, and the boat may be difficult to get on plane and may bounce.



# CONTROLS/INDICATORS

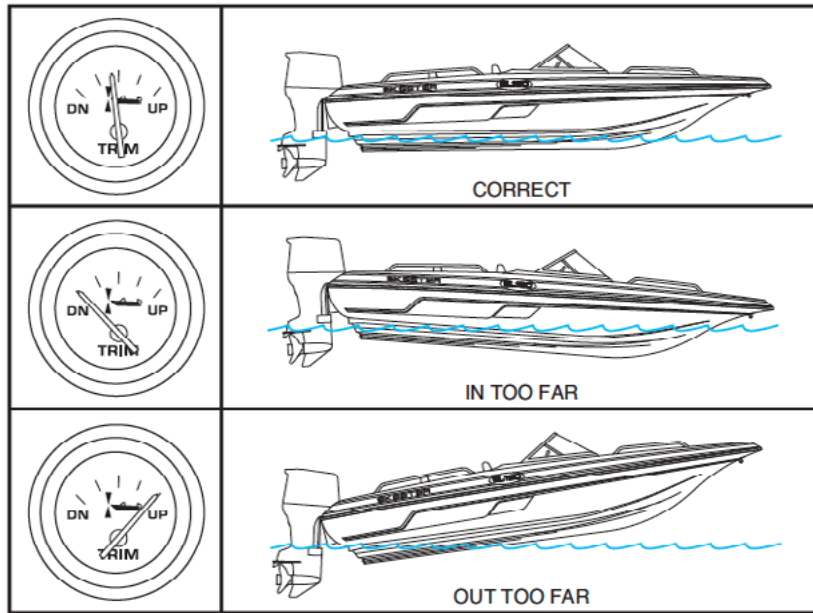

9343-017a

Figure 4-1



**DO NOT trim the outboard motor out too far or the boat may begin to “porpoise” (bounce up and down). Porpoising reduces control and visibility and lowers top speed and fuel efficiency. Failure to maintain control or visibility could result in serious injury or death.**

See your outboard motor owner’s manual for power trim operation information.

# CONTROLS/INDICATORS

---

## INSTRUMENTS

**NOTE:** Types of gauges and switches vary by model. Not all models have all the following items. Some of the following items are optional and cost extra. Skeeter reserves the right to change specifications without notice.

Some outboard motors are equipped with a multigauge to monitor the engine motor management system and other functions. See the outboard motor owner's manual if your Skeeter boat is equipped with such a system.

### **Trim Gauge (If Equipped)**

The trim gauge indicates bow position of the boat in the water. This is achieved by changing the angle of the outboard motor.

### **Sonar Fishfinder and Depth sounder**

See the fishfinder and depth sounder operations manual.

### **Water Pressure Gauge (If Equipped)**

The water pressure gauge monitors the cooling system pressure of the engine. See your outboard motor owner's manual for information.

### **Voltmeter (If Equipped)**

The voltmeter indicates voltage to the batteries from the charging system.

### **Tachometer**

The tachometer registers engine speed in revolutions per minute (RPM). See your outboard motor owner's manual for the correct operating range of the engine.

### **Speedometer**

The speedometer indicates the speed of the boat in miles per hour. Be sure the speedometer pitot tube is clean and free from debris. Also make sure the speedometer tube is not pinched and allows for proper operation of the gauge.

### **Fuel Gauge**

The fuel gauge registers the fuel level in the gas tank and not gallons. In some cases, because of the shape and size of the tank, when the gauge registers 1/2, there may be as much as 3/4 of a tank of fuel. Due to the various conditions affecting the way a boat floats, the gauge may register differently when the boat is on the trailer, at rest, or on plane.

# CONTROLS/INDICATORS

---

## SWITCHES

### **Bilge Switch**

The bilge switch activates the bilge pump, which eliminates excess water in the bilge. To prevent damage to the pump, be sure the switch is kept in the OFF position unless the pump is in use.

### **Courtesy Light Switch**

The courtesy light switch activates interior lights for nighttime illumination.

### **Navigation Lights Switch**

The navigation lights switch activates the bow and stern lights in the RUN position and just the stern light in the ANC position. The lights should be in the RUN position while under way and in the ANC position when anchored or tied in open water or channels. The ANC light is not required if tied up at a dock or beached.

**NOTE: Operate your boat between sunset and sunrise using the navigational lights. Navigational lights are legally required to indicate direction and right-of-way at night.**

### **Accessory Switches**

Accessory switches are installed for use and convenience when installing optional equipment.

### **Horn Switch**

The horn switch activates the horn. It is momentary and will return to the OFF position when released.

# CONTROLS/INDICATORS

---

## CIRCUIT BREAKERS / FUSES

The main power supply at the battery, automatic bilge pump switches, and trolling motor systems is protected from current overloads by circuit breakers or fuse holders at their power supply or at the battery in the positive (+) lead.

### Circuit Breakers

Some main switch panels and trolling motor wiring are equipped with circuit breakers. The buttons will be labeled with the item they protect. If the circuit protected has a current overload, the breaker will trip and power will be discontinued. The cause of the overload must be determined and eliminated before resetting the circuit breaker. Reset the circuit breaker by pressing its button.

### Fuses

Automotive-type fuses are located under the console to protect some electrical systems.



**DO NOT exceed the recommended fuse sizes or bypass the fuse safeguard. Always install the proper (type and rating) fuses whenever replacing or changing fuses.**

Any electrical accessories added to the boat must be fused for safety.

## ELECTRICAL SYSTEM

Skeeter boats have sophisticated electrical systems to provide service and function to their owner. Power is supplied from batteries located in the aft rigging compartment directly in front of the engine. Red positive (+) leads and black negative (-) leads with ring terminals for connecting to batteries are located in this compartment. There will be three or four heavy gauge wires for the trolling motor system to connect to the trolling motor batteries. There will be two lighter gauge wires for the boat supply or “accessory” harness to connect to the engine cranking battery. Some system models are built to locate trolling motor batteries and wiring under the front deck.

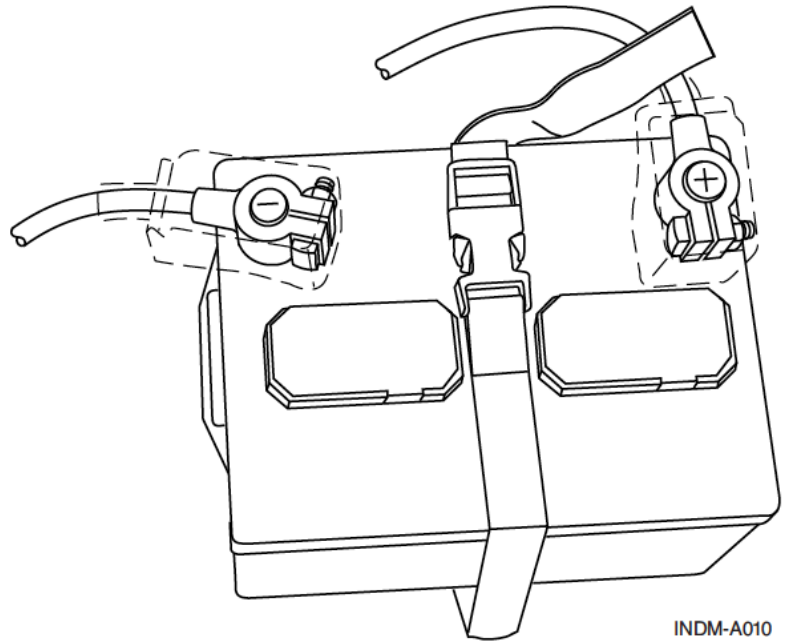

INDM-A010

**Typical Marine Battery**  
**Figure 5-1**

## FUEL SYSTEM

Your Skeeter boat is equipped with an internal fuel system meeting current federal requirements.



**Leaking fuel is a fire and explosion hazard. Inspect system regularly. Examine fuel system for leaks or corrosion at least annually.**

**Failure to inspect the fuel system could allow fuel leakage to go undetected, becoming a fire or explosion hazard.**

The fuel system must be thoroughly inspected and repaired, if necessary, before operating the boat. Do not operate your boat knowing you have a fuel system problem.

If you suspect your boat has a fuel system problem, contact your Skeeter Dealer.

If your boat has dual fuel tanks, it will be equipped with two fuel fill caps. Fuel is delivered from both tanks to your outboard motor.

If your boat is equipped with a capped second fuel delivery connector, this is used to supply fuel to a “kicker motor.”

**NOTE:** While filling the boat's gas tank(s), please adhere to the gas nozzle's indication (Clicking Sound) that the tank(s) are full. Overfilling will adversely affect the boat fuel system (i.e. Ventilation) causing an interruption of the fuel flow to the engine.



Figure 5-2

## BILGE

### Bilge Pump

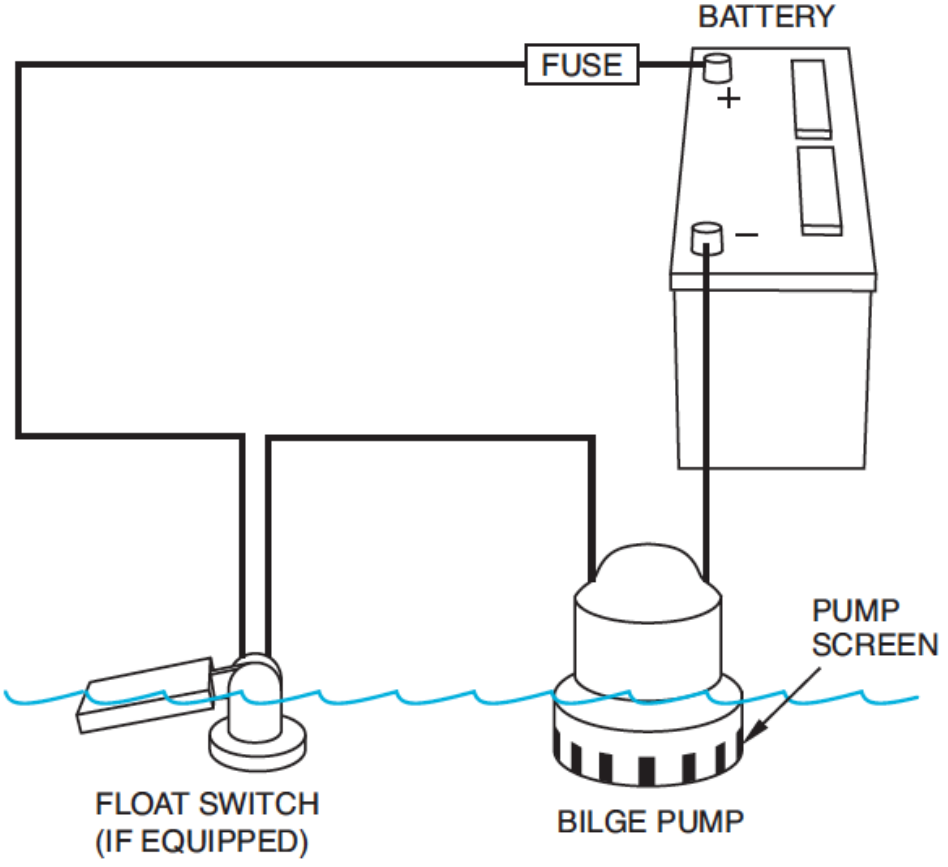

Figure 5-3

SKE-0102-A

A bilge pump is designed to remove excess water which may accumulate in the bilge area. Make sure the bilge pump is not blocked with debris and is in proper working order. Check the pump screen occasionally and monitor the stream from the bilge pump outlet. If you recognize a weak stream at the bilge outlet, this may indicate a blocked pump screen or a poor electrical contact. If you recognize no stream, this could indicate a blown fuse or a pump malfunction.

Never operate a dry bilge pump or damage to the pump will occur.

Figure 5-2 shows a typical bilge pump system with an automatic float switch.

## Battery Connections

See the manufacturer's engine manual for battery requirements.

Maintain the battery or batteries following the manufacturer's recommendations.

Disconnect all battery cables before servicing the boat, its electrical system, battery, or the outboards and make sure metal objects do not touch the battery posts.

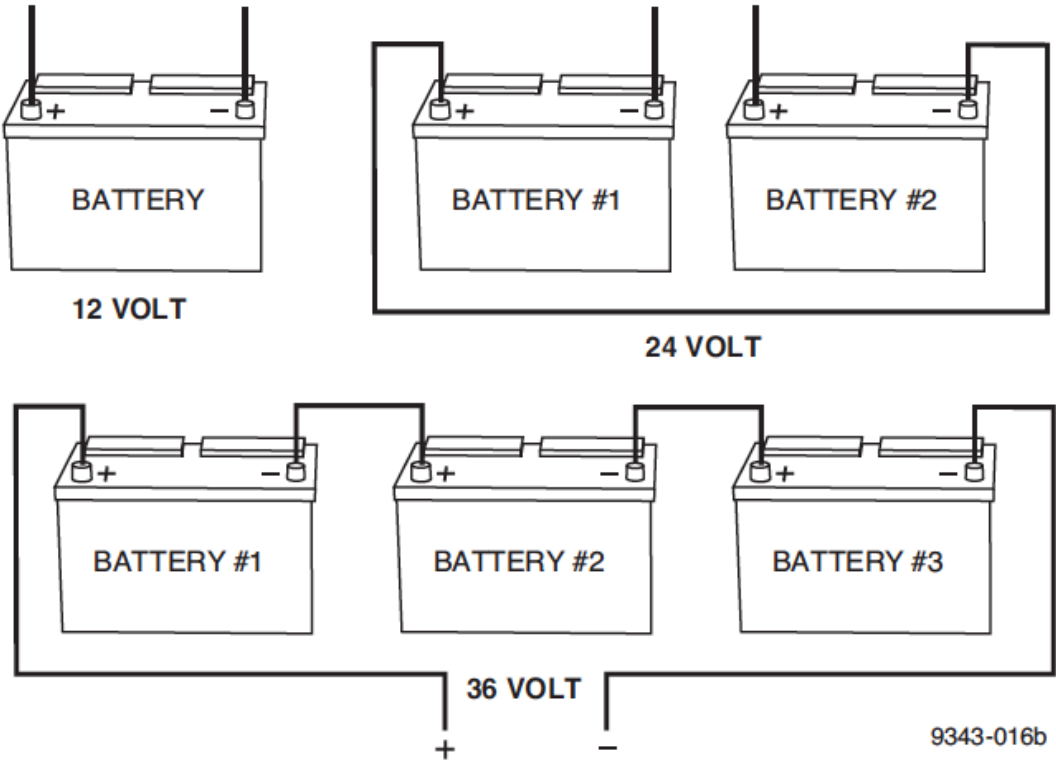

Figure 5-4

Figure 5-3 shows a typical 12-, 24-, and 36-volt connection.



Keep the battery connections clean, tight, and insulated to prevent shorting or arcing and causing a possible explosion. Install protective covers and check the connections often to make sure they are clean and tight.

**DO NOT** charge your batteries in the boat if your boat is not equipped with an on board charging system.

Make sure all accessories and outboards are in the OFF position before making any battery connections.

## **Battery Connections (Cont.)**

Keep your outboard motor battery on a separate circuit from your electric trolling motor battery or batteries. If you operate your electric outboard from your outboard motor battery, it will discharge the battery and your battery may not have the required amperage to crank your outboard motor.

**NOTE:** Connect the 12-volt accessories to the outboard motor's cranking battery.

**If your boat is equipped with a 24- or 36-volt trolling motor, interference can occur if you connect your accessories to the trolling motor batteries. Interference can also occur if the transducer wire is strapped or run next to the trolling motor's battery cable.**

**If your trolling motor is connected to the battery using a receptacle, make sure all the connections are tight. If you operate your trolling motor with loose connections, damage to the trolling motor can result.**

**Never check your connections by running either of your outboards out of the water.**

## **Tilt Steering Latch (If Equipped)**

Push the latch away from you to adjust the steering wheel angle. The steering wheel has five positions and locks into a detent.

## **12-Volt Accessory Port (If Equipped)**

The 12-volt accessory port allows you to conveniently connect an accessory to your electrical system. The accessory port is fused with a 15-amp fuse.

## **CAUTION**

**Do not connect an accessory which will exceed this fuse rating.**



### Hydraulic Steering

Maintenance of the steering system varies with usage and climate and should be inspected by a qualified marine mechanic at least twice a year or at the first sign the steering system is not operating normally.

To check the oil level, remove the steering fluid fill cap. The oil level should be within 1/2 in. (13 mm) of the bottom of the filler hole. See the manufacturer's literature for more information on maintenance.

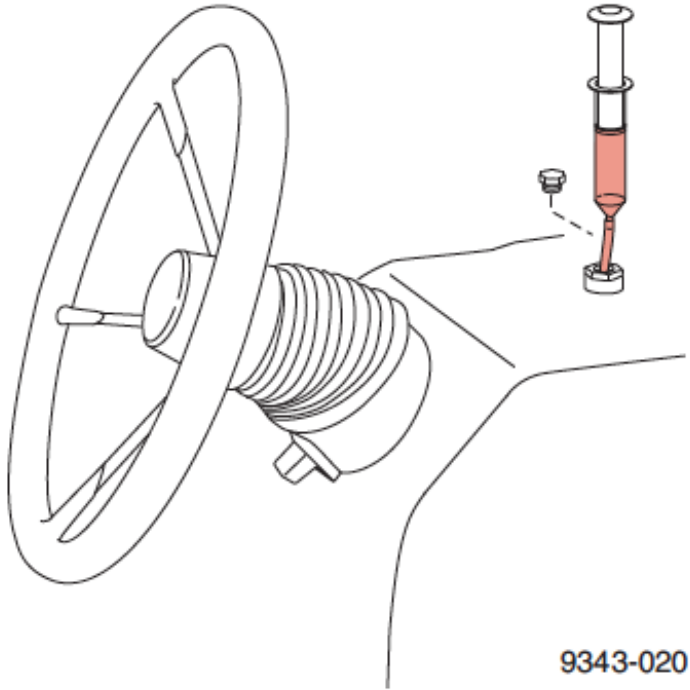

Hydraulic Steering  
Figure 5-5



### WARNING

Failure to comply with steering maintenance checks may result in loss of steering which may cause an accident with injury or death.

### Battery Charging System (If Equipped)

The battery charging system allows you to charge the batteries without removing the batteries from the boat. See the manufacturer's literature for operating instructions.

Make sure all accessories and outboards are in the OFF position when connecting to the power source and charging the batteries.



### WARNING

Do not charge your batteries in the boat unless your boat is equipped with an on board charging system.

### Electric Trolling Motor

See the electric trolling motor owner's manual supplied in your owner's kit for electric trolling motor operation and maintenance procedures.

Many Skeeter models are pre-wired with an electric trolling motor panel with plug.

## OPERATION



### Before Starting the Engine

**SEVERE INJURY OR DEATH MAY RESULT IF YOU IGNORE ANY OF THE FOLLOWING:**

- Before operating your Skeeter boat, become familiar with all controls. Consult your Skeeter Dealer about any control or function you do not fully understand.
- Attach the engine stop cord (lanyard) to a secure place on your clothing, or your arm or leg and keep it free from steering wheel or other controls so that the engine stops if the operator accidentally leaves the helm. Failure to attach the engine stop cord could result in a runaway boat if the operator is ejected.
- Check throttle and steering for proper operation before starting the engine.
- Shift into NEUTRAL before starting engine.
- Never start the engine or let it run any length of time in an enclosed area. Exhaust fumes contain carbon monoxide, a colorless, odorless gas that may cause loss of consciousness and death within a short time. Always operate the boat in an open area.

1. There is a hull drain plug at the bottom of the stern in the center. Be sure it is securely tightened before launching the boat.
2. Put the remote control lever in the NEUTRAL position. Turn the ignition key to “Start.” When the engine starts, release the key. See the outboard motor owner’s manual for more information.

### Stopping the Engine

To stop the engine, return the remote control lever to the NEUTRAL position, then turn the key switch to “Off.” The engine can also be stopped by pulling the engine shut-off switch cord (lanyard).



**Once the engine has stopped, you have very little steering control over the boat. You could collide with another boat, a dock, or other obstacles.**

**NOTE:** Remove the ignition keys and the engine shut-off switch cord (lanyard) if the boat will be left unattended. Stopping the engine immediately after operating at high rpm is not recommended. Let the engine cool off at idle or low speed for a few minutes first.

## DRIVING YOUR SKEETER BOAT

### Getting To Know Your Boat

Operating your Skeeter boat requires skills acquired through practice over a period of time. Take the time to learn the basic techniques well before attempting more difficult maneuvers.

Boating with your new Skeeter boat can be a very enjoyable activity, providing you with hours of pleasure. But it is essential to familiarize yourself with the operation of the Skeeter boat to achieve the skill necessary to enjoy boating safely. Before operating this Skeeter boat, read this Owner's/ Operator's Manual, the owner's manual for your outboard motor, all Warning and Caution labels on the boat and motor, as well as all other informational material supplied with your boat.

### Boating with Passengers

When one or more passengers are on board, the boat may handle differently, so operating it requires a higher degree of skill.

Passengers should sit so the weight in the boat is balanced from side-to-side and bow-to-stern as much as possible. If passenger seats are provided on your boat in front of the helm, be sure the operator's view ahead is not obstructed when they are used.

Passengers must sit in one of the seats and hold onto the grips while putting both feet on the deck.

When passengers are on board, make sure they are seated and holding on before you start to accelerate. An unprepared passenger could lose balance and fall.

### Boarding from a Dock or Landing Jetty

1. Board the boat from the side. One person should board at a time by stepping into the boat. Never jump in. Avoid stepping on slick gel coat surfaces on the boat's gunwales, especially if wet.
2. Sit in one of the seats provided and put both feet on the deck.

### Stopping

The Skeeter boat is not equipped with a separate braking system. It is stopped by water resistance after the remote control lever is moved back to idle. The stopping distance varies depending on gross weight, water surface conditions, and wind direction. The boat slows down as soon as the remote control lever is returned to idle but will coast for a distance before fully stopping. If you are not sure you can stop in time before hitting an obstacle, apply throttle and turn in another direction.

You will lose most steering control if you put the remote control lever in NEUTRAL.

## Docking

1. Make sure no obstructions, boats, or swimmers are close to the boat. Come to a stop before you reach the dock.
2. Notice how wind and water currents are affecting boat movement as you attach your mooring lines and fenders.
3. Approach the dock at idle speed. Use reverse as necessary during slow-speed maneuvering to help control speed and direction. Position the boat according to wind and water conditions.



**Do not use your hand, arm, or other part of your body to try to keep the boat from hitting the dock. You could be injured if the boat pushes against the dock.**

Wind or current pushing boat away from dock:

Slowly approach the dock at about a 45° angle. Secure the bow to the dock, then use engine power or a boat hook to gently move the stern to the dock.

Wind or current pushing boat toward dock:

Slowly maneuver to a shallow angle and allow the boat to move toward the dock.

Try to use wind or current to your advantage when docking.

No wind or current:

Approach the dock at a shallow angle. Secure the bow to the dock, then use engine power or a boat hook to gently move the stern to the dock.

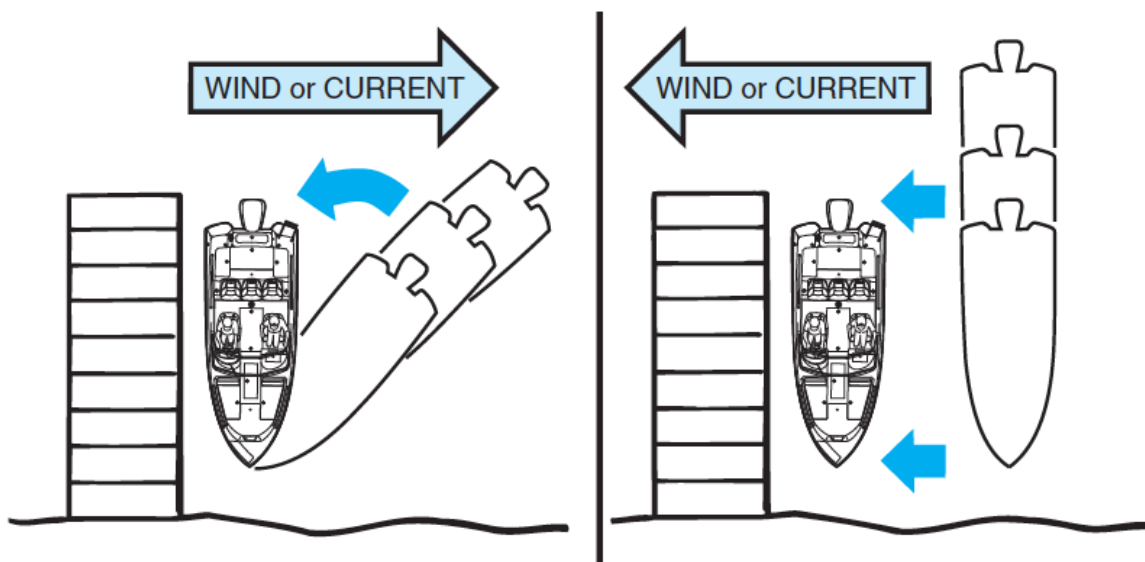

9343-011

**Docking**  
**Figure 6-1**

# OPERATION

## Leaving a Dock

Because boats steer from the stern, the stern first moves in the direction opposite your desired turn. It is especially important to understand this characteristic when leaving a dock. If you simply turn the wheel to steer the bow away from the dock, as you would when driving a car out of a parking space, you will drive the stern of the boat into the dock. Following is a basic maneuvering technique which can be used in most circumstances.

1. With engine idling and the bow still moored to the dock, turn the steering wheel toward the dock. This will start to move the stern of the boat away from the dock.
2. When the stern is out a few feet, release the bow mooring then steer in the direction you want the bow to move. Open the throttle slightly and begin to move away from the dock.

## Crossing Wakes and Swells

You will not always have flat, smooth water. There will be swells, wakes from other boats, etc. The best way to cross wakes and swells is with the least jolt to you and the boat. Small swells are not as difficult to cross as larger swells or wakes. Crossing a sharp wake gives more of a jolt than a broad swell.

To cross a wake or swell, change your speed and choose the angle at which you cross the wake or swell. Usually, a slower speed and “quartering” the wake (crossing at an angle) will reduce the jolt.

Two other things you may notice. The first is that crossing a group of wakes or swells is not as easy or smooth as crossing just one wake. The second is that when you quarter the wake or swell the boat will try to steer away from the wake or swell. When crossing at a 45° angle, you may not notice this, but at a smaller angle, say 10°, it can be very strong. Be prepared to steer and balance as necessary.

## BOAT TRIM

### Getting To Know Your Boat

The performance of your Skeeter boat depends on load weight and distribution. Distribute weight evenly, from bow to stern, and also from port to starboard.

After loading, the boat's trim can be adjusted by changing the outboard trim angle. Overloading of passengers, personal equipment, and supplies could result in an accident, especially in rough waters. Maintain a balanced load at all times. Passengers must always sit in a designated seating area.

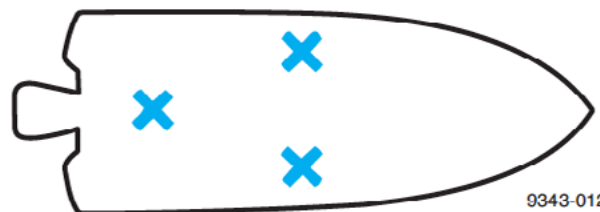

Proper  
Distribution  
Figure 6-2

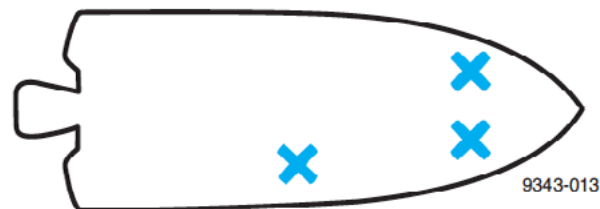

Improper  
Distribution  
(Bow Heavy)  
Figure 6-3

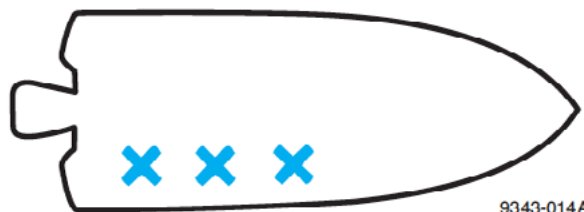

Improper  
Distribution  
(Starboard  
Heavy)  
Figure 6-4

# GETTING UNDER WAY

There are many things to consider to make your boating trip safe and enjoyable. You are responsible for the safety of all passengers, the boat, and any damage the boat or its wake may cause. Keep passengers from blocking your view so that you do not run into other boats, swimmers, water skiers, personal water vehicles, or aids to navigation.

## SAFETY CHECKLIST



**Do not operate the boat if any problem is found during this inspection. A problem could lead to an accident during the outing causing severe injury or death. Problems found during this inspection should be handled by your Skeeter Dealer.**

The following checks are essential to safe boating and must be performed before starting the engine.

- Check the weather report, wind, and water conditions.
- Check that required safety equipment is on board and in proper operating condition.
- Check that the fire extinguisher is fully charged.
- Be sure the boat is not overloaded.
- Be sure the operator's visibility is not obstructed.
- Check that all maintenance has been performed.
- Check the fuel system for leaks and fumes.



**Avoid serious injury or death from fire or explosion. A leak-free fuel system is a must for safe boat use. Check your boat for fuel leaks and fumes before, during, and after each use.**

## SAFETY EQUIPMENT

Federal and local laws require certain safety equipment to be on board at all times. In addition, responsible boaters carry other equipment in case of emergency. Check with local boating authorities for any additional requirements over and above the federal requirements.

## BOARDING

When boarding the boat, always step in. Do not jump. Avoid stepping on fiberglass or other potentially slippery surfaces. Board one person at a time.

Do not board the boat while carrying gear. Set the gear on the dock, board the boat, and then pick up the gear.

Do not use the outboard as a boarding ramp; use the boarding ladder. To prevent injury, make sure the engine is OFF when swimmers, drivers, and skiers are boarding.

Skeeter urges you and all others operating your boat to seek certified instruction from the local boating authorities.

This section is designed to present the most basic operational principles. It is NOT intended to cover all conditions encountered during operation. Therefore, the principles in this manual are limited to the facts related directly to the operation of your boat, while the responsibility for the proper application of these principles belongs to you.

## MANEUVERING TECHNIQUES

Steering response depends on three factors: outboard position, motion, and throttle.

When making tight maneuvers, it is important to understand the effects of turning. Since both thrust and steering are at the stern of the boat, the stern will push away from the direction of the turn. The bow follows a smaller turning circle than the stern.

The effects of unequal propeller thrust, wind, and current must also be kept in mind. While wind and current may not always be present, an experienced boater will use them to his or her advantage. Unequal thrust is an aspect shared by all single-engine propeller-driven watercraft. A clockwise rotation propeller tends to cause the boat, steering in the straight ahead position, to drift to starboard when going forward, and to port when going backward. At high speed, this effect is usually unnoticed, but at slow speed, especially during backing, it can be powerful. For this reason, many veteran boaters approach the dock with the port side of the boat toward the dock, if possible.

Stopping (checking headway) is a technique that must be developed. Reverse thrust is used to slow and stop the boat. The momentum of the boat will vary according to the load as well as the speed. Make it a practice to slow to idle (no-wake) speed before shifting into reverse.

It is best to learn maneuvering skills in open water away from traffic. Adequate practice is the only way to develop your boating skills.

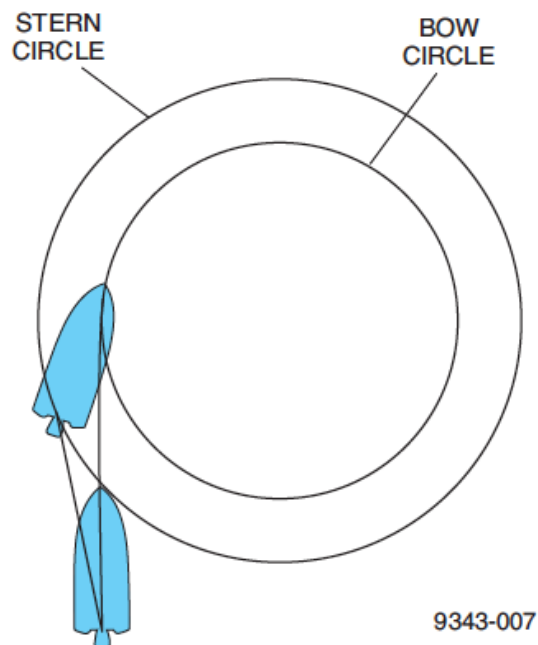

**Maneuvering  
Figure 8-1**

## ANCHORING

Always anchor from the bow. Anchoring only from the stern will make the boat unsteady. A strong current can pull a stern anchored boat underwater. Select an anchor appropriate for your boat and water conditions. A “Danforth” (or fluke) type anchor is suitable for most applications; your dealer can help you choose an anchor.

1. Make sure the anchor line is securely tied to the anchor and to the bow eye.
2. Move the boat to the spot where you want to lower the anchor, heading the boat into the wind or current. Stop the boat, then lower the anchor until it hits bottom.
3. While keeping tension on the line, slowly back up the boat until you have let out line that is 4 to 6 times the depth of the water. For example, if you are anchoring in 10 ft (3 m) of water, let out 40 to 60 ft (12 to 18 m) of line. Secure the line.
4. Pull on the line to be sure the anchor is holding. Also, periodically check your boat’s position against the shoreline to make sure it is not drifting and dragging the anchor. Reset it if necessary.
5. To pull in (“weigh”) the anchor, start the engine and move forward, keeping tension on the line as you pull it in. When the anchor line is straight up and down, pull hard to lift the anchor from the bottom material.
6. If the anchor is stuck on the bottom, try this: Let out a few feet of anchor line and secure the line to the boat again. Slowly maneuver the boat around the anchor until the anchor pulls loose. Keep the line taut during this procedure.

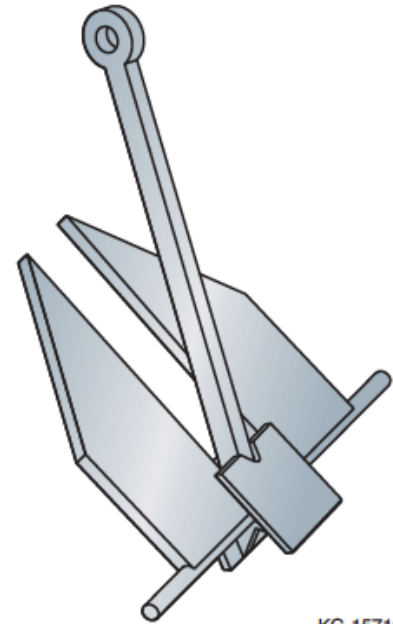

KC-1571C

**Danforth Anchor**  
**Figure 8-2**

## PERFORMANCE BOATING

Your Skeeter boat is a high-speed, high-performance boat. DO NOT be tempted to push your boat to its limits until you are completely familiar with its operating characteristics.

We recommend that you never operate the boat without first having an initial orientation and familiarization/demonstration ride with your dealer or an operator experienced with the boat/outboard combination. All boats perform differently.



**DO NOT trim the outboard out too far or the boat may begin to “porpoise” (bounce up and down). Porpoising reduces control and visibility and lowers top speed and fuel efficiency. Failure to maintain control or visibility could result in serious injury or death.**



## PROPELLERS

Care and selection of your propeller is very important to proper boat operation. See your outboard motor owner's manual for propeller information.

Problems associated with propellers include ventilation, cavitation, and blow-out. These problems have similar symptoms and are best diagnosed by an expert. Consult your Skeeter Dealer if you think you have a propeller-related problem.



**Never change a propeller without disconnecting the battery from your outboard. Your propeller can have sharp edges. Handle with care.**

## POST-OPERATION CHECKS

### Post-Operation Checks

These post-operation procedures are developed to help preserve the long-term appearance and reliability of your Skeeter boat. Perform these procedures as soon as possible after the boat is loaded back on the trailer after the day's use.

Some owners plan to moor their boat seasonally, rather than keeping it on the trailer between uses. The procedures described in this section may not be possible if your Skeeter boat is moored in the water. Boats which are moored will require periodic removal from the water to clean the hull and outboard motor area. The frequency of this maintenance will depend upon whether the water is salt or fresh, as well as other local water conditions.

Leaving the boat in the water for extended periods will accelerate the rate of normal deterioration of the outboard motor and hull finish. Stray electrical voltage in the water, marine organisms, and saltwater corrosion are a few of the conditions that can adversely affect the life of many Skeeter boat components.

1. Follow the post-operation or storage instructions in your outboard motor's Owner's/Operator's Manual.
2. Wash down the hull, helm, and outboard motor with fresh water. Remove the drain plug at the stern to let any water drain from the bilge.

**NOTE: This boat is equipped with either an automatic or a manual electric bilge pump that removes excess water from the bilge while you are under way. However, some residual water remains that must be drained by removing the drain plug.**

Tighten the hull drain plug securely before launching the Skeeter boat. Clean any foreign material, such as dirt or sand, from the threads before installing the drain plug.

3. Spray a rust inhibitor, such as Yamalube Silicone Protectant and Lubricant, on metallic parts to minimize corrosion.

## TRAILERING



**Avoid accident and injury from improper trailering.**

- **The trailer must be matched for the boat's weight and hull.**
- **The towing vehicle must have the capacity of pulling the load. Pulling a load that exceeds the towing capacity may cause loss of control.**
- **Be sure the boat is secured to the trailer and the trailer is properly hitched to the towing vehicle before towing.**

A trailer is provided as standard equipment with your Skeeter boat. If you need to obtain another trailer, choose one that is manufactured to carry a boat of the size and weight of your Skeeter boat. Check the certification label on the left forward side of the trailer. This label is required to show the Gross Vehicle Weight Rating (GVWR), which is the load carrying capacity of the trailer plus the trailer's weight. Be sure that the total weight of your boat, any cargo, and the trailer weight itself does not exceed the GVWR.

### Hitch

The trailer hitch ball must match the size of the socket on the trailer hitch coupler. Hitches are divided into classes that specify the gross trailer weight (GTW) and the maximum tongue weight. Always use a hitch rated for the same or higher class. Use a bolted-on or welded-on hitch; clamp-on bumper hitches are not recommended. Be sure the trailer hitch's release handle is latched with the lock pin installed before towing.

Use safety chains between the towing vehicle and the trailer so the trailer will not detach completely from the towing vehicle if it accidentally comes loose from the hitch ball. Crisscross the chains under the trailer tongue so the tongue will not hit the road surface if it falls loose. Rig the chains as tightly as possible while allowing just enough slack to permit tight turns.

Be sure the tongue weight (vertical weight on the hitch point) is correct. Generally, 5% to 10% of the combined weight of the boat and trailer should be on the tongue. Too much or too little weight can cause difficult steering or trailer swaying.

### Trailering Checklist

- Check your state laws to be sure your trailer meets all regulations, such as proper licensing, brake, axle load, and safety chain requirements.
- Check trailer for any loose fasteners or damaged parts.
- Check tires for proper inflation.
- Check wheel bearings and wheel lug nuts before each trip.
- Check tail, brake, and turn signal lights for proper operation.
- Secure the bow of the boat to the trailer with the winch line and also with the chain. Secure the stern cleats to the trailer with tie-downs.

- Take down and store the bimini top, if used. The top is not designed to stay unsecured on the Skeeter boat at highway speeds.
- Carry a spare tire for the trailer, along with sufficient tools to change the tire.
- While traveling, check the wheel hubs on the trailer whenever you park. If the hub feels abnormally hot, have the bearing inspected before continuing your trip. On longer trips, it is a good idea to carry a set of spare wheel bearings, seals, and races.
- When making a turn, do not cut corners. The trailer has a smaller turning circle so it turns more sharply around the corner than the towing vehicle.
- Before backing your trailer into the water, disconnect the light plug from the towing vehicle. This will reduce the likelihood of the lights blowing out when submerged.

## Backing Your Trailer

It takes practice to back a trailer successfully. If you are not familiar backing up with a trailer, practice first in an open area away from obstacles.

Keep the following points in mind:

- Back slowly. Make steering adjustments in small steps.
- Turn the towing vehicle's wheels opposite the direction you want the trailer to go.
- After the trailer begins moving, turn the towing vehicle to follow it.
- Have a second person stand by to help direct you with hand signals.

## Launching

As a courtesy to other boaters, prepare your Skeeter boat for launching before using the ramp. Each launch may have particular differences, such as ramp angle, prevailing wind, waves, and water currents. If possible, watch a couple of boaters launch their boats first to notice any problems. While every boater develops a preferred launch procedure, here is a recommended general procedure:

1. Perform the Pre-Operation Checks shown on page 1-8 that can be performed on land.
2. Remove all trailering tie-down lines from the boat and attach your docking lines and fenders, if used.
3. Back the trailer down the ramp as close to 90° to the shoreline as you can. If possible, have a second person stand aside as an observer. Stop when the wheels are at least halfway submerged. Set the parking brake.
4. Remove the bow line from the bow eye.
5. Back the trailer farther into the water until just the tops of the fenders show, then reset the parking brake. Board the boat and start it. If possible, remain on the trailer until the engine is warm and is responding to throttle.
6. Back the boat out into the water, watching carefully for people, other boats, or obstacles.

## Loading

1. Back the trailer down the ramp as close to 90° to the shoreline as you can. If possible, have a second person act as an observer while standing to the side of the boat. Stop when the tops of the trailer's fenders are about 3 in. (7.6 cm) above the waterline.
2. With the boat moving at the slowest idle speed, guide the boat onto the support rails. Use throttle only if necessary for steering ability.



## WARNING

Using too much throttle can cause the boat to jump over the front of the trailer which can result in injury to the boat operator and bystanders. Use only enough throttle to maneuver the boat into the correct position.

3. Make sure the boat is centered on the support rails and is headed straight for the bow stop (bumper board). Ease the boat forward until the bow rests against the bow stop.
4. Attach and tighten the winch line.

## CAUTION

- The winch line is not designed to pull the boat onto the trailer.
- The winch line should not be the only line securing the bow during trailering. Use the chain along with the winch to secure the boat to the trailer.

5. Pull the trailer up the ramp out of the way of other boaters. Attach the bow and stern tie-downs.
6. Follow the Post-Operation Checks on page 8-3.

### Transom Saver

The transom saver is designed to protect your boat, outboard motor, and trailer.

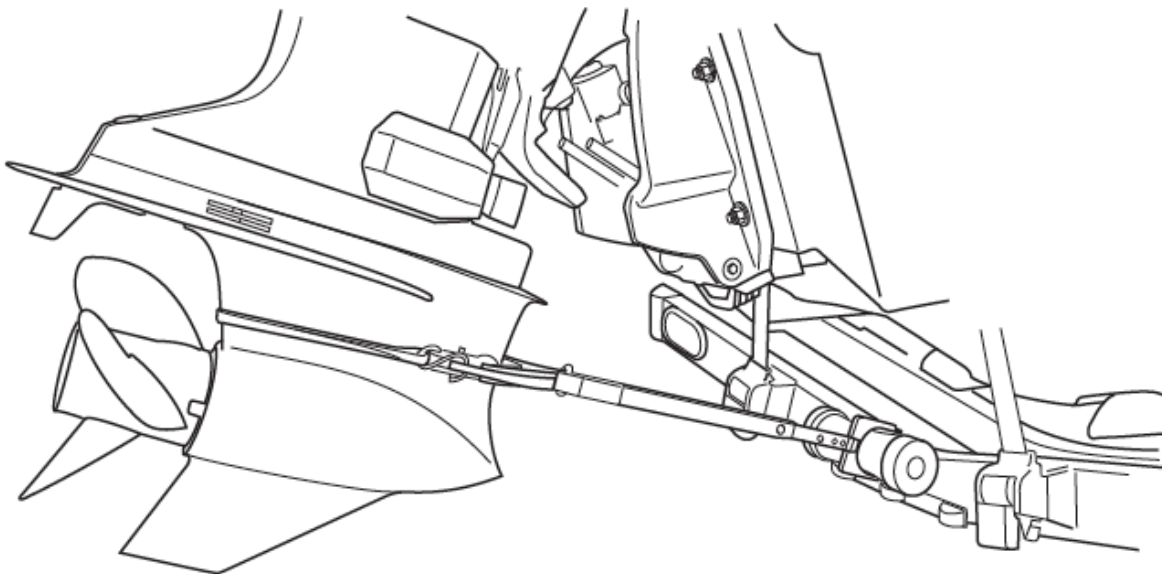

9343-022a

**Transom Saver**  
**Figure 8-3**



**Transom Saver**  
**Figure 8-4**

Many outboard motors are equipped with a sleeve type transom saver, which also can be used in conjunction with the trailer-mounted type.

# CARE / MAINTENANCE

---

This section describes how to care for and maintain your Skeeter boat. Periodic inspection and maintenance of items listed in this section are absolutely necessary.

## REPAIRS AND MODIFICATIONS

Your Skeeter boat is designed to meet all applicable standards in place at the time of manufacture for proper operation in the harsh marine environment. Because of the possibility of interference with the design of the boat, owner installation of additional equipment or modification of factory equipment is not recommended.

In addition, DO NOT attempt to make repairs unless you have the qualification and experience to do so, have the necessary authorized repair information, and use approved marine replacement parts. See your authorized Skeeter Dealer for any needed repairs, installation of additional equipment, or appropriate modifications to your boat that will not compromise safety, design integrity, or warranty coverage.

## ELECTRICAL



**Use extreme caution when checking for an electrical problem.**

An electrical system problem must be treated seriously. Do not operate your boat knowing there is a problem with the system. When a problem is discovered, have your Skeeter Dealer service it immediately.

**NOTE: The electrical system is designed to protect your boat from short circuits or an overload condition. Any modifications to the system should be done by your Skeeter Dealer.**

# CARE / MAINTENANCE

## Battery

Periodically check the battery restraint system, making sure the battery is secured.



- Batteries contain sulfuric acid which can cause severe burns. Wear protective clothing to avoid acid contact with your skin and eyes. Failure to do so could result in severe injury.
- The battery compartment doors **MUST** be secured in the **OPEN** position for ventilation when charging any batteries.
- Be sure to inspect your boat for and eliminate fuel fumes and their cause prior to connecting a battery charger to your batteries.

Check the batteries frequently for signs of corrosion. If corrosion is evident, clean terminals with a baking soda and water solution and a wire brush. Before cleaning, remove the vent caps and seal the vent wells with corks to prevent the solution from getting inside the battery.

**NOTE:** Some batteries are sealed and cannot be filled.

Check the fluid levels in the cells. Usually, a level approximately 1/4 to 1/2 in. (6 to 13 mm) above the plates is sufficient. If needed, fill with distilled water. **DO NOT** overfill!

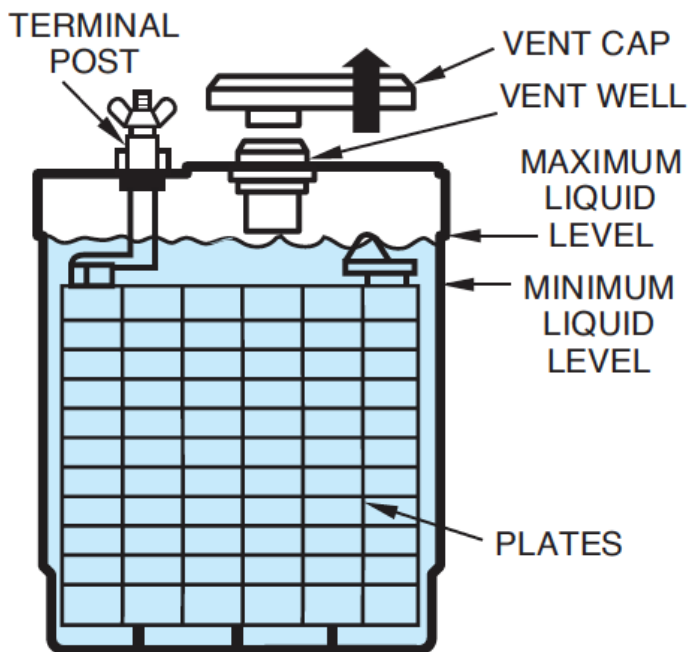

KC-1620C

Figure 9-1



Batteries produce explosive hydrogen gas. **DO NOT** attempt starting your engine with jumper cables under any circumstances. Keep all sparks, flames, and smoking material away from the batteries. Risk of spark at the battery post igniting gasoline or hydrogen fumes is too great. Always wear skin and eye protection when near batteries and keep the battery compartment lids open to provide adequate ventilation when charging. An explosion can cause blindness or other serious injuries.

Batteries are perishable products and will self discharge. If you operate your boat sparingly, you may want to charge your batteries occasionally.

# CARE / MAINTENANCE

## Direct Battery Charging

See **ELECTRICAL SYSTEM** on page 5-1 for charging trolling motor batteries information.

Secure the battery compartment doors in the OPEN position. Observing polarity, connect the battery charger to the battery posts.

## On board Charger

Charging through the optional on board charger can be performed by securing the battery compartment doors in the OPEN position. Plug a properly grounded extension cord into a 110-volt AC outlet. Place the receptacle end into the permanently mounted charger inlet on the boat. Charging will begin automatically.

## CORROSION PROTECTION

### Galvanic Corrosion

Galvanic corrosion (electrolysis) is the breakup of metals due to the effects of electrolytic action. When dissimilar metals are immersed in a conductive fluid such as salt water, an electric current is produced, similar to the action of a battery. The softest of the metals will be the first to become damaged. If not stopped, a great deal of damage could occur.

If you operate in salt, polluted, or brackish waters, your boat should be equipped with a transom-mounted zinc anode to prevent damage to those metal parts coming in contact with the water. By design, the anode is self sacrificing. It is slowly eroded by electrolytic action and requires periodic inspection for deterioration. If the zinc anode shows extreme erosion, it must be replaced for continued protection.

### CAUTION

**DO NOT paint or coat a zinc anode with any substance. Once covered, the anode will not provide protection from galvanic corrosion. Replace the anode if it is deteriorated 50% or more.**

Consult your Skeeter Dealer for additional information concerning galvanic corrosion.

### Salt Water Corrosion

The entire boat, outboard, and trailer should be rinsed with fresh water and washed immediately after use in salt water. If the boat is used primarily in salt water, wax the hull monthly and apply corrosion inhibitor to all hardware. See your Skeeter Dealer for products suitable for the marine salt water environment.

See your outboard owner's manual for cooling system flushing information.



# CARE / MAINTENANCE

---

## GENERAL MAINTENANCE

### Boat Finish

Most things, when left outdoors, man-made or natural, will gradually deteriorate from exposure to sunlight, water, dust, and chemicals in the air. Such exposure may cause your boat's surface to show a variety of changes, including but not limited to:

- Chalking (fine powdery whiteness on the surface)
- Fading (gradual loss of color)
- Clouding (milky looking spots)
- Yellowing
- Loss of gloss

Routine, periodic maintenance is the only practical way to keep the surface of your boat looking good.

### Maintenance Procedures

You will get years of boating pleasure while slowing the changes described previously by following the simple maintenance procedures described below.

### When Not in Use

Sunlight and dust can be your boat's worst enemies. Keep your boat covered when not in use. A boat cover (option available from your Skeeter Dealer), preferably light in color, is a wise investment to help prevent damage while the boat is stored or on the road. DO NOT use sheet plastic or other nonporous materials, which can trap moisture between the cover and the boat's surface.

### Each Month

Wash the boat's surface with a mild soap to remove normal accumulation of soil and stain. Avoid any kind of alkaline cleansers such as trisodium phosphate (TSP), abrasives, bleaches, or ammonia. DO NOT use acids or other strong chemicals to clean the boat. For best results, use cleaners recommended for fiberglass and follow the instructions on the label.

### Twice Yearly (Minimum)

Wax your boat's gel coat surface to help prevent loss of gloss and protect the finish. Use only wax recommended for use on fiberglass and follow the instructions carefully. Apply only a thick coat of wax to a small area (3 x 3 ft [1 x 1 m]) at a time using clean applicator cloths. If you are using a power buffer, never use one that turns faster than 4000 RPM. High heat may build up and cause damage to the finish. NEVER wax a gel coat surface that has been sitting in the sun and is hot. Never wax a gel coat surface in direct sunlight.

### Carpet

Your Skeeter carpet has built-in stain and soil release characteristics for easy, less costly maintenance. Maintenance such as vacuuming, hosing, and washing should be performed regularly. Most stains and mildews are easily removed from the carpet. To clean mildew off the carpet, first check the cleaner on a small area of carpet that is hidden to determine compatibility of cleaner and carpet. "FISH ATTRACTANTS," which are commonly sprayed on lures, and some insect repellents will cause deterioration of the carpet backing. Spray these formulas away from your boat carpet, and clean any spills promptly. DO NOT use pressure sprayers to clean boat carpet.

# CARE / MAINTENANCE

## Upholstery

Skeeter takes pride in manufacturing our own custom interiors. The vinyl fabric in your Skeeter interior was specially selected to take the tough punishment of the elements and hard usage of an active boater.

## For General Care

- Do not use the seat straps as a handle when carrying seats.
- An authorized Skeeter Dealer should install seats.
- Use quality upholstery cleaner to clean the vinyl upholstery.
- Protect the seats from the weather and ultraviolet sunrays. Use a high-quality vinyl conditioner containing UV inhibitors.
- Check the seat fasteners. Only Skeeter-approved seats and associated hardware should be used in your boat. These seats and hardware should be periodically inspected for wear, tear, and/or fatigue. If you notice these types of signs, please contact your Skeeter Dealer and have them replaced via the Skeeter Customer Service for a nominal fee.

## Paints

If your boat is kept in water where marine growth is a problem, the use of anti-fouling paint may reduce the growth rate. Be aware of environmental regulations that may govern your paint choice. Contact your local boating authorities for information.

## Cleaning Agents

Household cleaners should be used sparingly and not discharged into waterways. DO NOT mix cleaners and be sure to use plenty of ventilation in enclosed areas. DO NOT use products which contain phosphates, chlorine, solvents, or non-biodegradable or petroleum based products. Many citrus-based cleaners are excellent for marine cleaning purposes and can be better choices for the environment. Read product labeling carefully.

## FUEL SYSTEM



**Avoid serious injury or death from fire or explosion. A leak-free fuel system is a must for safe boat use. Check your boat for fuel leaks and fumes before, during, and after each use.**

If you find a leak, have your Skeeter Dealer repair the leak before your next boat outing.

Only USCG-approved fuel hoses must be used on the fuel system.

# CARE / MAINTENANCE

## MOTOR MOUNTS

Having a solid connection between the motor and the boat is very important to prevent damaging structural integrity. Your Skeeter may be equipped with one or more of the following mounting systems. Check all mounting system bolts for the proper torque of 75 ft-lb (10.4 kg-m) every 6 months.

### Motor to Transom Bolts

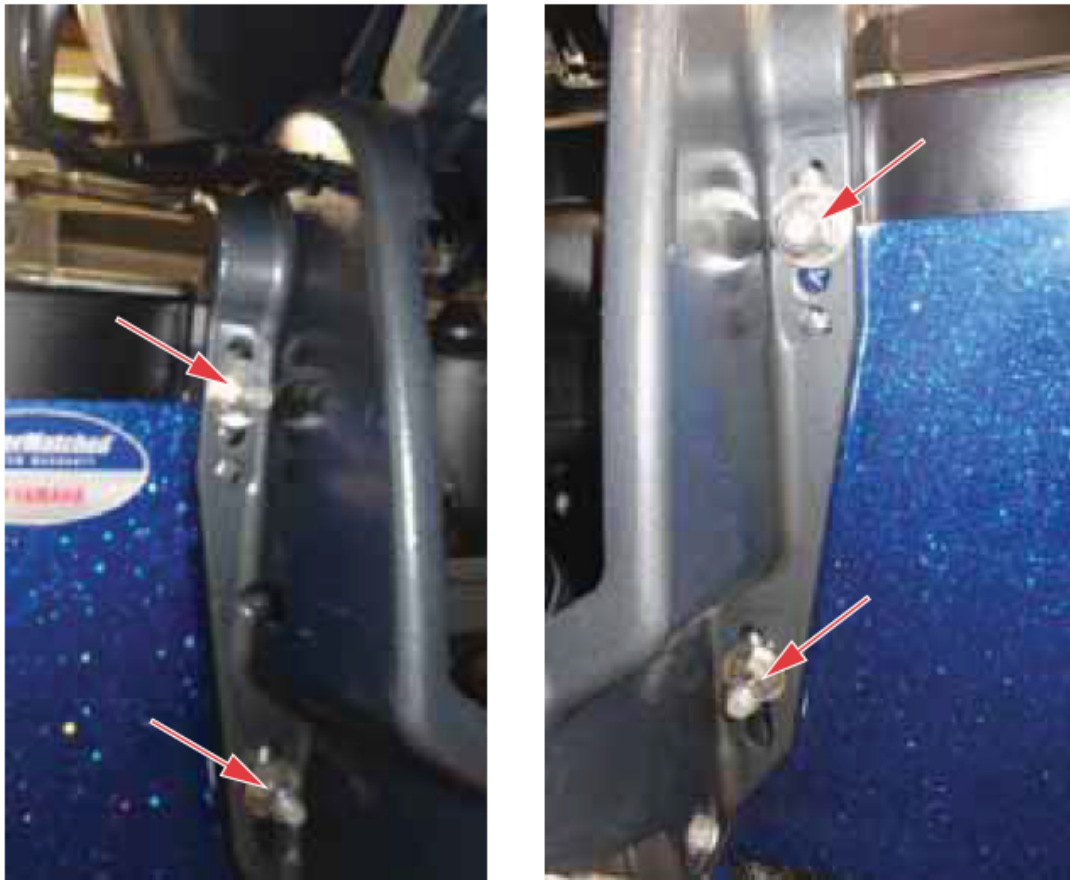

SKE-0133-A

Figure 9-2

# CARE / MAINTENANCE

## Torque Transfer System Bolts



SKE-0134-A

Figure 9-3

## Jack Plate to Transom Bolts

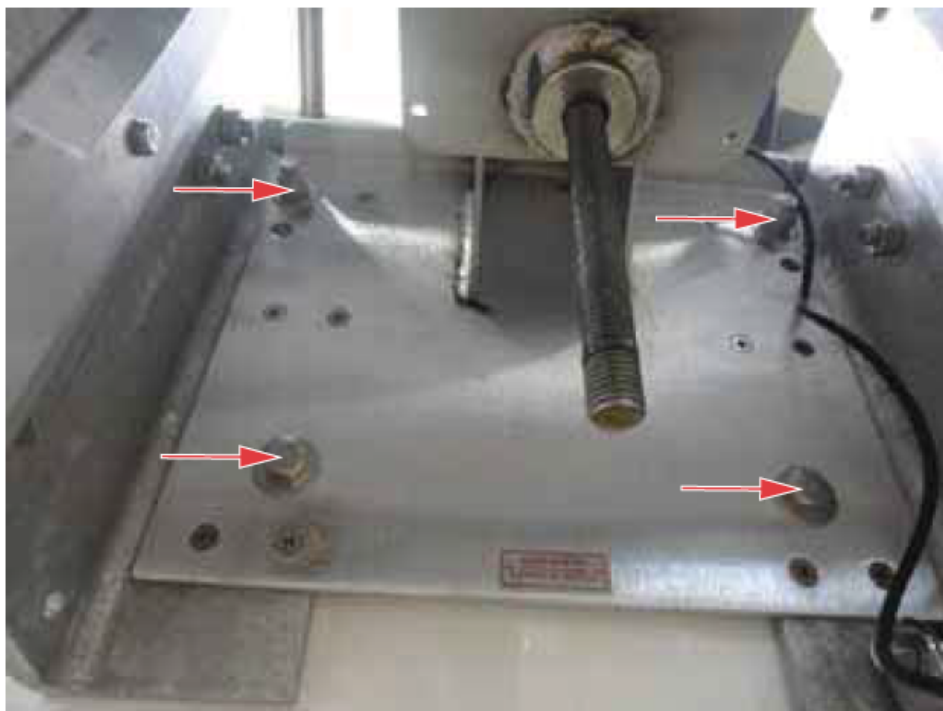

SKE-0135-A

Figure 9-4

# CARE / MAINTENANCE

## Motor to Transom Bolts



SKE-0136-A

Figure 9-5

## STEERING SYSTEM

Frequently inspect the steering system for smooth, free, and full-range operation. In addition, check the original self-locking nuts used to fasten the steering link rod between the steering cable(s) and the engine.

**Have your Skeeter Dealer check for proper lubrication, any unusual backlash, and any component wear of the steering system at least once a year.**



# TROUBLESHOOTING

The following chart will assist you in finding and correcting minor problems with your Skeeter boat. See your outboard owner's manual for any problem concerning the starting, shifting, or operation of the outboard.

Some problems may require the skills of a trained technician and special service tools. Please contact your Skeeter Dealer for assistance.

## TROUBLE CHECK CHART

| PERFORMANCE                                      |   |
|--|---|
| Symptom  | Possible Cause  |
| Poor boat performance                            | <ul style="list-style-type: none"> <li>• Contaminated fuel</li> <li>• Uneven load distribution</li> <li>• Improper power trim setting</li> <li>• Improper propeller selection</li> <li>• Engine problem</li> <li>• Marine growth on hull</li> </ul> |
| Poor gas mileage                                 | <ul style="list-style-type: none"> <li>• Improper power trim setting</li> <li>• Marine growth on hull</li> <li>• Engine problem</li> </ul>  |
| Excessive vibration                              | <ul style="list-style-type: none"> <li>• Damaged or fouled propeller</li> <li>• Engine problem</li> </ul>   |
| Engine runs but boat makes little or no progress | <ul style="list-style-type: none"> <li>• Fouled or damaged propeller</li> <li>• Engine problem</li> </ul>   |
| PERFORMANCE                                      |   |
| Symptom  | Possible Cause  |
| Electrical problem                               | <ul style="list-style-type: none"> <li>• Open circuit breaker or blown fuse</li> <li>• Loose wiring connection</li> <li>• Defective switch or gauge</li> </ul>  |
| Dim or no lights                                 | <ul style="list-style-type: none"> <li>• Circuit breaker tripped or in OFF position</li> <li>• Battery discharged</li> </ul>  |

## PREPARING BOAT FOR STORAGE

Storage or winter lay-up requires special preparation to prevent damage to your boat. If the boat is stored in below freezing temperatures, water inside the boat and in the livewell systems may freeze causing damage. Damage to the boat due to improper storage will not be covered by the warranty. The following procedures should help prevent damage to your boat.

### CAUTION

**Follow the instructions in the outboard owner's manual for off-season storage, stabilizing the fuel system and stabilizing the oil injection system, if applicable.**

Remove the drain plug immediately after taking the boat out of the water. After washing, raise the bow of the boat enough to allow as much water as possible to drain while performing the following storage preparations.

- Thoroughly clean the hull, deck, and interior of the boat as soon as it is removed from the water. Cleaning at this time is easier because the marine growth is still wet. Be sure to allow for a couple of days of air drying to prevent mildew due to trapped air. See **GENERAL MAINTENANCE**, in Section 9.
- Drain the livewell system. See **LIVEWELL SYSTEM** on page 3-14.
- Apply wax to the entire surface of the boat. See **GENERAL MAINTENANCE**, in Section 9.
- Remove the batteries from the boat. Clean, fully charge, and store them in an area not subject to freezing temperatures. DO NOT store batteries close to heat, spark, or flame producing devices. See Battery in Section 9.
- Perform all scheduled maintenance for the outboard and the trailer.
- Use proper protection to cover the outboard and the boat while in storage.

### Reactivating the Boat After Storage

- Charge and install the batteries. See Battery in Section 9.
- Check condition of the livewell system. See **LIVEWELL SYSTEMS**, in Section 3.
- Check the fuel system. Verify the condition of all hoses and fuel line. Should a fuel hose need replacing, use only USCG-approved hose. Be sure all hose clamps are tight.
- Check and lubricate the steering system.
- Verify the condition of all safety equipment.
- Verify proper operation of the engine stop switch and lanyard.



## LIFTING

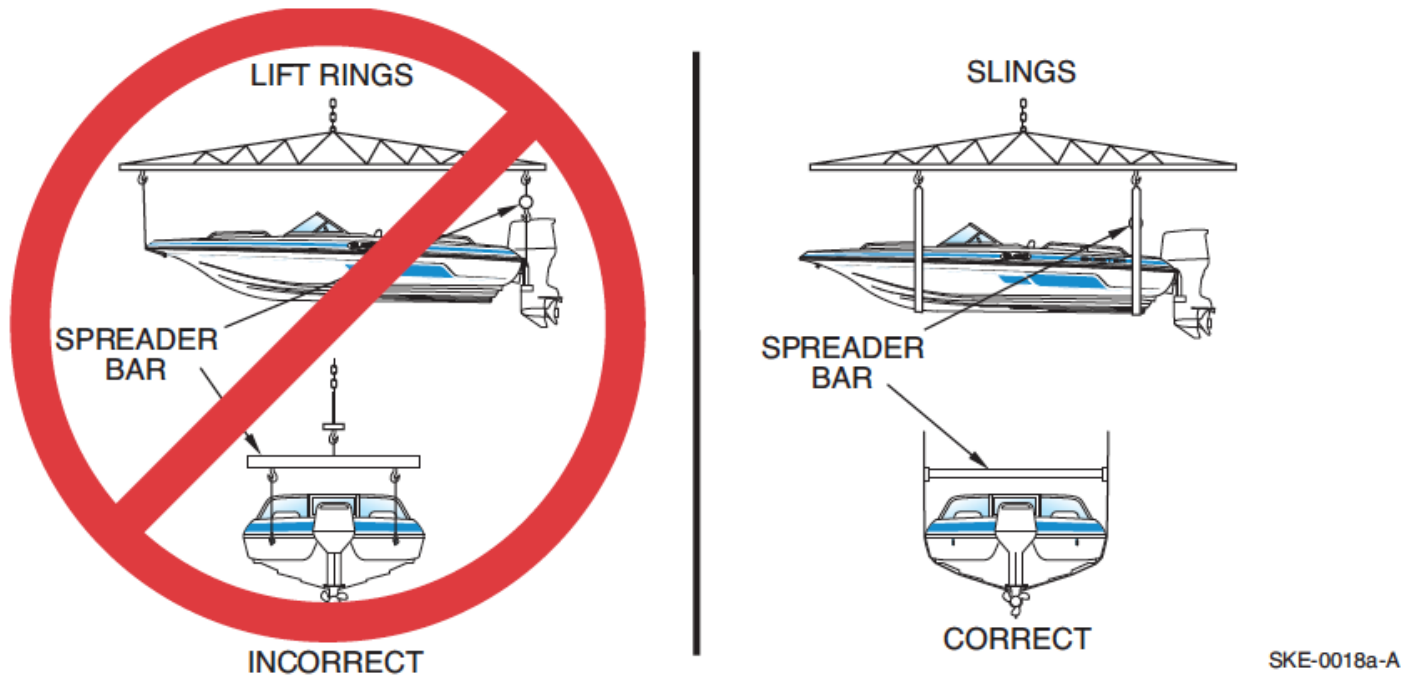

Figure 11-1



Do not attach lifting cables to the bow eye, cleats, water-ski tow eye, or grab handles. Serious damage to the boat can occur. Use only a sling designed specifically for lifting boats.

If you need to remove the Skeeter boat from the water without a trailer, use these guidelines:

- Use a sling-type lifting mechanism designed for lifting boats. The sling should be covered with a protective material to prevent damage to the hull gel coat.
- Use spreader bars to avoid side stress to the hull that may cause cracks in the gel coat and fiberglass.
- Attach guidelines to the bow eye and stern tie down cleats to control movement of the boat during lifting.
- Remove all people and all cargo from the boat. Drain any excess water from the bilge using the bilge pump.
- Be sure all people are standing clear, then lift boat slowly and just far enough to verify that the boat is securely held and properly balanced. If necessary, lower the boat again and adjust the slings.
- When ready, lift the boat slowly and carefully.

## TRAILERING

The manufacturer of your trailer has provided you with a vehicle designed for many years of convenient, trouble-free service. It is up to you to use and care for it properly, to be sure that it will perform safely and satisfactorily. Instructions on how to do this are included in the trailer owner's manual. Read, learn, understand, and act on the information included in this important book. Proper trailer maintenance and safety procedures are essential to safe and enjoyable trailering.



**Read, understand, and follow the instructions for trailer ownership and use in the trailer owner's manual included with your Skeeter owner's package.**

# GLOSSARY OF TERMS

---

**ABOARD** – On or in the boat.

**ABYC** – American Boat and Yacht Council, Inc.

**AFLOAT** – On the water.

**AFT** – Toward the rear or stern of the boat.

**AGROUND** – Touching bottom.

**AMIDSHIP** – Center or middle of the boat.

**ANCHOR** – (1) An iron casting shaped to grip the lake bottom to hold the boat. (2) The act of setting the anchor.

**ASHORE** – On the shore.

**ASTERN** – Toward the stern.

**BAIL** – To remove water from the bottom of the boat with a pump, bucket, sponge, etc.

**BAITWELL** – A miniature livewell used to store and keep live bait alive and healthy.

**BEAM** – The widest point on the boat.

**BEARING** – Relative position or direction of an object from the boat.

**BILGE** – The lowest interior section of the boat hull.

**BILGE KEELS** – The raised areas or aluminum extrusions on the bottom of a boat that parallel the keel.

**BOARDING** – To enter the boat.

**BOUNDARY WATERS** – A body of water between two areas of jurisdiction; i.e., a river between two states.

**BOW** – The front of the boat.

**BULKHEAD** – Vertical partition (wall) in a boat.

**BUNKS** – Carpeted trailer hull supports.

**BURDENED BOAT** – Term for the boat that must “give-way” to boats with the right-of-way.

**CAPACITY PLATE** – A plate that provides maximum weight capacity and engine horsepower rating information. It is located in full view of the helm.

**CAPSIZE** – To turn over.

**CAST-OFF** – To unfasten mooring lines in preparation for departure.

**CENTER LINE** – A lengthwise imaginary line which runs fore and aft with the boat’s keel.

**CHINE** – The point on a boat where the side intersects (meets) the bottom.

**CLEAT** – A deck fitting with ears to which lines are fastened.

**CONSOLE** – Also called helm. The steering wheel area of the boat.

**CRANKING BATTERY** – The main battery used for engine starting and electrical circuits.

**CURRENT** – Water moving in a horizontal direction.

**DECK** – The open surface on the boat where the passengers walk.

**DEEP CYCLE BATTERIES** – Special long-running batteries which can be repeatedly discharged and recharged without significant loss of power.

# GLOSSARY OF TERMS

---

**DOLLY WHEEL** – A rolling jack assembly at the front of the trailer used for positioning the coupler during trailer hookup.

**DRAFT** – The depth of the boat below the water line, measured vertically to the lowest part of the hull.

**ELECTROLYSIS** – The break-up of metals due to the effects of galvanic corrosion.

**FATHOM** – Unit of depth or measure; 1 fathom equals 6 ft (1.83 m).

**FENDERS** – Objects placed alongside the boat for cushioning. Sometimes called bumpers.

**FORE** – Toward the front or bow of the boat. Opposite of aft.

**FREEBOARD** – The distance from the water to the gunwale.

**FUEL SENDING UNIT** – The electrical device that is mounted on the outside of a built-in fuel tank and controls the dashboard fuel gauge.

**GIVE-WAY BOAT** – (1) Term for the boat that must take whatever action necessary to keep well clear of the boat with the right-of-way in meeting or crossing situations. (2) The burdened boat.

**GUNWALE** – The rail or upper edge of a boat's side.

**HEAD** – A marine toilet.

**HELM** – The steering wheel or command area.

**HULL** – The body of the boat.

**HYPOTHERMIA** – A physical condition where the body loses heat faster than it can produce it.

**IN-LINE FUSE** – A type of protective fuse located in the power wire of a direct current (DC) circuit usually near the battery.

**KEEL** – The lowest portion of the boat; extends fore and aft along the boat's bottom.

**LIST** – Leaning or tilt of a boat toward the side.

**MAKING WAY** – Making progress through the water.

**MARINE CHART** – Seagoing maps showing depths, buoys, navigation aids, etc.

**MOORING** – An anchor, chain, or similar device that holds a boat in one location.

**NAVIGATION AID** – Recognizable objects on land or sea such as buoys, towers, or lights which are used to fix position to identify safe and unsafe waters.

**NMMA** – National Marine Manufacturers Association

**NO-WAKE SPEED** – The speed at which a boat travels to produce an imperceptible wake.

**PFD** – Personal flotation device.

**PITOT TUBE** – See SPEEDOMETER PICKUP TUBE.

**PLANING HULL** – A hull designed to lift, thereby reducing friction and increasing efficiency.

**PORPOISE** – A condition in which the bow bounces up and down caused by trimming the engine too far out.

**PORT** – (1) The left side of a boat when facing the bow. (2) A destination or harbor.

**PRIVILEGED BOAT** – Term used for the boat with the right-of-way.

**RIGHT-OF-WAY** – Term for the boat that has priority in meeting or crossing situations. The stand on or privileged boat.

# GLOSSARY OF TERMS

---

**RULES OF THE ROAD** – Regulations for preventing collisions on the water.

**SPEEDOMETER PICKUP TUBE** – Also called pitot tube. The plastic device that extends below the bottom of the boat. It connects to the speedometer with plastic flexible tubing.

**SPLASHWELL** – The section of an outboard-equipped boat that is just forward of the transom.

**STAND-ON BOAT** – Term for the boat that must maintain course and speed in meeting or crossing situations. The privileged boat.

**STARBOARD** – The right side of the boat when looking towards the bow.

**STERN** – The back of the boat.

**STOW** – To pack the cargo.

**SURGE BRAKES** – A type of trailer braking system designed to automatically actuate when the tow vehicle's brakes are applied.

**TRANSDUCER** – The unit that sends/receives signals for the depth sounder.

**TRANSOM** – The transverse beam across the stern.

**TRIM** – Fore to aft and side to side balance of the boat when loaded.

**UNDER WAY** – Boat in motion; i.e., not moored or anchored.

**USCG** – United States Coast Guard

**WAKE** – The waves that a boat leaves behind when moving through the water.

**WATERWAY** – A navigable body of water.

**V-PAD** – A modified vee hull design with a small, flat area in the keel aft.

**VISUAL DISTRESS SIGNAL** – A device used to signal the need for assistance such as flags, lights, and flares.

# FLOAT PLAN

Copy this page and fill out the copy before boating. Leave the filled out copy with a reliable person who can be depended upon to notify the USCG or other rescue organization, should you not return as scheduled. Do not file this plan with the USCG.

Name \_\_\_\_\_ Telephone \_\_\_\_\_

Description of Boat:

Type \_\_\_\_\_ Color \_\_\_\_\_ Trim \_\_\_\_\_

Registration Number \_\_\_\_\_

Length \_\_\_\_\_ Name \_\_\_\_\_ Make \_\_\_\_\_

Other Info. \_\_\_\_\_

Persons Aboard: Name Age Address & Telephone

\_\_\_\_\_  
\_\_\_\_\_  
\_\_\_\_\_

Engine Type: \_\_\_\_\_ HP \_\_\_\_\_

No. of Engines: \_\_\_\_\_ Fuel Capacity: \_\_\_\_\_

Survival Equipment:

PFDs \_\_\_\_\_ Flares \_\_\_\_\_ Mirror \_\_\_\_\_ Smoke Signals \_\_\_\_\_

Flashlight \_\_\_\_\_ Food \_\_\_\_\_ Paddles \_\_\_\_\_ Water \_\_\_\_\_

Anchor \_\_\_\_\_ Raft or Dinghy \_\_\_\_\_ EPIRB \_\_\_\_\_

Radio: Yes \_\_\_ No \_\_\_ Type \_\_\_\_\_ Freq \_\_\_\_\_

Destination \_\_\_\_\_ Est. Time of Arrival \_\_\_\_\_

Expect to Return By \_\_\_\_\_

Auto Type \_\_\_\_\_ License No. \_\_\_\_\_ Parked \_\_\_\_\_

If not returned by \_\_\_\_\_ call the Coast Guard, or \_\_\_\_\_ (Local Authority).

Coast Guard Telephone Number: \_\_\_\_\_

Local Authority Telephone Number: \_\_\_\_\_

## **2022 AND NEWER SKEETER BOAT LIMITED WARRANTY**

This 2022 and Newer Skeeter Boat Limited Warranty provides you with protection against the expense of covered repairs for your boat that are required as a result of covered defects in materials or workmanship. This Limited Warranty provides you with specific coverage and explains your responsibilities in maintaining and operating your boat under this Limited Warranty. Please take the time to read and become familiar with this Limited Warranty.

Any new model year 2022 and newer Skeeter Boat (“Skeeter Boat”) purchased for personal, family, or household use (“Pleasure Use”) from any authorized Skeeter Boat dealer in the 50 United States or Canada by the original retail purchaser and registered for use in the customer’s country of residence (United States or Canada) by the dealer from the original retail purchase date (“Date of Original Purchase”) will be warranted against defects in material or workmanship for the period of time stated herein, subject to certain limitations and exclusions stated in this Limited Warranty. If the Skeeter Boat is purchased under the above conditions by federal, state, or local government agencies for official purposes (“Government Use”), only the Structural Limited Warranty and Component Limited Warranty stated herein apply. If the Skeeter Boat is purchased under the above conditions for commercial trade, including, but not limited to, carrying passengers for hire (“Commercial Use”), only the Structural Limited Warranty stated herein applies.

### **PERIOD OF STRUCTURAL LIMITED WARRANTY FOR PLEASURE USE, GOVERNMENT USE, AND COMMERCIAL USE**

The hull, floor, stringers, and transom of the Skeeter Boat shall be warranted against major structural defects in material and workmanship for Pleasure Use, Government Use, and Commercial Use for the duration of ownership of the first retail purchaser (“Structural Warranty Period”).

### **PERIOD OF COMPONENT LIMITED WARRANTY FOR PLEASURE USE AND GOVERNMENT USE ONLY**

The following factory-installed components shall be warranted against defects in material and workmanship to the original purchaser for a period of three (3) years for Pleasure Use and Government Use only from the Date of Original Purchase (“Component Limited Warranty”), subject to the limitations as outlined below. The Component Limited Warranty is not applicable to Commercial Use and is not transferable.

- Carpet
- Steering helm, cylinder, hoses, and cables
- Aeration pumps, valves, and timer
- Boat electrical system
- Fuel tanks
- Factory-installed gauges
- Deck hardware, such as locks, hinges, cleats, fasteners, switches, and lights

## **PERIOD OF COSMETIC LIMITED WARRANTY FOR PLEASURE USE ONLY**

Appearance-related items not covered by the Component Limited Warranty will be warranted against defects in material and workmanship to the original retail purchaser during the Cosmetic Limited Warranty Period of one (1) year from the Date of Original Purchase. Repairs will only be authorized after determination that there is a defect in material or workmanship. The Cosmetic Limited Warranty is not applicable to Government Use or Commercial Use and is not transferable.

## **OBTAINING REPAIRS UNDER WARRANTY**

During the period of warranty, Skeeter or its authorized representative, or any authorized Skeeter Boat dealer will, free of charge, repair or replace, at Skeeter's sole option and discretion, any part adjudged defective due to faulty workmanship or material from the factory provided the original owner returns the Skeeter Boat, with transportation prepaid, to an authorized Skeeter Boat dealer or, if necessary, to the Skeeter factory or any other reasonable place designated by Skeeter. Should Skeeter elect to replace the entire Skeeter Boat, the replacement boat shall be subject to the remaining duration and conditions of this Limited Warranty and not be subject to an extended or new warranty unless otherwise provided for by both parties in writing. The liability of Skeeter shall in no event exceed the actual cash value of the part adjudged defective and labor to install it. The Skeeter Boat owner will be responsible for all transportation, haulouts, loss of time, inconvenience, travel expenses, loss of use, launch, towing, storage, and other expenses incurred in returning the boat for warranty service. All parts replaced under warranty shall become the property of Skeeter.

## **CUSTOMER'S RESPONSIBILITY**

Under the terms of this Limited Warranty, the customer will be responsible for ensuring the Skeeter Boat is properly operated, maintained, and stored as specified in the applicable Owner's/Operator's Manual. The owner of the Skeeter Boat shall give notice to Skeeter or its authorized representative or authorized Skeeter Boat dealer of any and all apparent defects within ten (10) days of discovery and make the Skeeter Boat available as directed for inspection and/or repairs. Warranty repairs will be performed by Skeeter, or its authorized representative, in accordance with the provisions of this Limited Warranty.

## **GENERAL EXCLUSIONS FROM WARRANTY**

This Limited Warranty will not cover the repair of damages to your Skeeter Boat caused by abuse, alteration, modification, neglect, vandalism, and non-adherence including, but not limited to, the following:

- Racing or modification of original parts or abnormal strain.
- Lack of periodic inspection and proper maintenance or off-season storage as described in the Owner's/Operator's Manual.
- Damage due to installation of parts or accessories that are not provided by Skeeter.
- Damage as a result of accidents, collisions, contact with foreign materials, improper trailering, failure to cover the boat properly when not in use, submersion, unreasonable use, using boat components for something other than their intended purpose, vandalism, or tampering.
- Damage caused by growth of marine organisms.
- Deterioration due to normal wear and tear.
- Damage caused by overpowering, which is exceeding the maximum horsepower specifications on the capacity plate provided on the Skeeter Boat.
- Acts of God or force majeure.
- Improper dealer preparation including, but not limited to, cleaning and final adjustments or alignments in preparing the Skeeter Boat for final delivery.



## **SPECIFIC EXCLUSIONS FROM WARRANTY**

This warranty will not cover the following items:

- Window breakage, and leakage around windshields, windows or hatches or other apertures.
- Gel coat finish flaws due to impact.
- Gel coat discoloration or blistering.
- Varnishes and paints, as well as stainless steel or chrome-plated, powder-coated, or anodized-aluminum finishes.
- Damage caused by exposure to the elements, including, but not limited to, color changes or fading from sun exposure, or the use of cleaners or chemicals not recommended in writing by Skeeter.
- Items not manufactured by Skeeter. However, for components factory-installed by Skeeter as original equipment, on the Skeeter Boat, that are warranted instead by a component manufacturer ("Item"), Skeeter warrants the cost of labor for removal and reinstallation of the Item if the defect in the Item is warranted by its manufacturer.
- Damage caused by engines, outdrives, propellers, controls, batteries, engine brackets, trailers, electric trolling motors, fish/depth finding devices, or other equipment or accessories not manufactured by Skeeter whether or not warranted by other such manufacturer.
- Installation of engines or accessories installed by anyone other than Skeeter or an authorized Skeeter Boat dealer.
- Upholstery damage including rips, tears and fading to upholstery, carpets, and canvas.
- Damage resulting from non-compliance with Skeeter's maintenance and care instructions or other specifications.

## **STRUCTURAL LIMITED WARRANTY TRANSFERABILITY FOR PLEASURE USE ONLY**

During the first ten (10) years after the Date of Original Purchase, the first retail owner of a Skeeter Boat purchased and timely registered for Pleasure Use from an authorized Skeeter Boat dealer may transfer a Structural Limited Warranty to the second retail owner within ten (10) days of the date of purchase by the second retail owner. After transfer, the duration of the Structural Limited Warranty shall be for the remainder of the ten (10) year period from the Date of Original Purchase. The second owner, with proof of ownership, should contact Skeeter at (903) 964-0541 to initiate the warranty transfer. The transfer of the warranty is effective: (i) upon the date Skeeter receives written or electronic notice of the transfer; (ii) when the two-hundred-dollar (\$200.00) transfer fee is paid in full to Skeeter; and (iii) if the second retail owner's use is Pleasure Use. The warranty may only be transferred the one (1) time to the second retail owner, not any subsequent owners. Transfer of the Structural Limited Warranty is not permitted for Government Use or Commercial Use. To obtain information on this Limited Warranty without charge, you may contact Skeeter at Skeeter Products, Inc. One Skeeter Road, Kilgore, Texas 75662 (903) 984-0541.

## **CONDITIONS OF WARRANTY**

- Skeeter reserves the right to alter models, change color specifications, component parts, materials, equipment, and prices, or to cease production of certain models at any time without notice. Such changes may be made without incurring obligations to equip or modify units produced prior to the date of such changes.
- Removal of engines or other equipment not installed by Skeeter prior to repairs and subsequent reinstallation of same after repair is not the responsibility of Skeeter and shall be paid for by the boat owner.
- This Limited Warranty does not cover failure of the Skeeter Boat to meet any representation as to the Skeeter Boat's performance characteristics, including but not limited to estimated speed, weight of the Skeeter Boat, or fuel consumption.

SKEETER MAKES NO OTHER WARRANTY OF ANY KIND, EXPRESS OR IMPLIED. ALL IMPLIED WARRANTIES OF MERCHANTABILITY AND FITNESS FOR A PARTICULAR PURPOSE WHICH EXCEED THE OBLIGATIONS AND THE LIMITS STATED IN THIS WARRANTY ARE HEREBY DISCLAIMED BY SKEETER AND EXCLUDED FROM THIS WARRANTY.

ALL SKEETER BOATS PURCHASED AND/OR REGISTERED FOR USE OUTSIDE THE 50 UNITED STATES AND CANADA ARE SOLD AS IS-NOTHING ELSE IS PROMISED OR IMPLIED.

SOME STATES/PROVINCES DO NOT ALLOW LIMITATIONS ON HOW LONG AN IMPLIED WARRANTY LASTS, SO THE ABOVE LIMITATION MAY NOT APPLY TO YOU. THIS WARRANTY DOES NOT COVER ANY INCIDENTAL OR CONSEQUENTIAL DAMAGES INCLUDING LOSS OF USE, LOSS OF TIME, AND INCONVENIENCE. SKEETER'S LIABILITY IS LIMITED TO REPAIRING OR REPLACING THE SKEETER BOAT AS PROVIDED IN THIS WARRANTY. SOME STATES/PROVINCES DO NOT ALLOW THE EXCLUSION OR LIMITATION OF INCIDENTAL OR CONSEQUENTIAL DAMAGES, SO THE ABOVE EXCLUSION MAY NOT APPLY TO YOU.

THIS WARRANTY GIVES YOU SPECIFIC LEGAL RIGHTS, AND YOU MAY ALSO HAVE OTHER RIGHTS WHICH VARY FROM STATE TO STATE OR PROVINCE TO PROVINCE.

THIS DOCUMENT CONTAINS THE ENTIRE WARRANTY GIVEN BY SKEETER AND THERE ARE NO TERMS, PROMISES, CONDITIONS, OR WARRANTIES, OTHER THAN THOSE CONTAINED HEREIN. NO ORAL OR WRITTEN INFORMATION OR ADVICE GIVEN BY SKEETER, ITS DEALERS, REPRESENTATIVES, AGENTS OR EMPLOYEES SHALL CREATE A WARRANTY BY SKEETER OR IN ANY WAY INCREASE THE SCOPE OF THIS WARRANTY.

Skeeter Products, Inc.  
One Skeeter Rd.  
Kilgore, Texas 75662  
(903) 984-0541

This is Your  
**WARRANTY STATEMENT**  
Please Retain For Your Records

DATE OF PURCHASE: \_\_\_\_\_

Skeeter supports our country's vast fisheries by promoting "catch and release," and is committed to preserving the environment in our manufacturing practices.

At Skeeter, we continually strive to improve and enhance specifications without notice. Please confirm with your Skeeter dealer prior to purchase. Specifications and measurements are approximations and subject to variances. Some boats shown with optional equipment.

Follow all instructional materials and local and federal laws. Always wear recommended protective apparel. Operate within your capabilities, allowing extra time and distance for maneuvering. Always operate in a responsible manner, respecting the environment and others around you. Don't drink alcohol or use drugs and then operate your boat.

Boat smart from the start. Take a boating safety course and get a free vessel safety check annually for your boat. For more information, contact the United States Coast Guard Auxiliary at 800-368-5647 or [www.cgaux.org](http://www.cgaux.org), or the United States Power Squadrons at 888-FOR-USPS or [www.usps.org](http://www.usps.org).



Skeeter Products, Inc.  
One Skeeter Road  
Kilgore, TX 75662





**WARNING:** Operating, servicing and maintaining a recreational marine vessel can expose you to chemicals including engine exhaust, carbon monoxide, phthalates, and lead, which are known to the State of California to cause cancer and birth defects or other reproductive harm. To minimize exposure, avoid breathing exhaust, service your vessel in a well-ventilated area and wear gloves or wash your hands frequently when servicing this vessel. For more information go to [www.P65warnings.ca.gov/marine](http://www.P65warnings.ca.gov/marine)

SKEETER DEEP-V OWNER'S/OPERATOR'S MANUAL

©2022 by Skeeter Products, Inc.

All rights reserved.

Any reprinting or unauthorized use without the written permission of Skeeter Products, Inc. is expressly prohibited.